

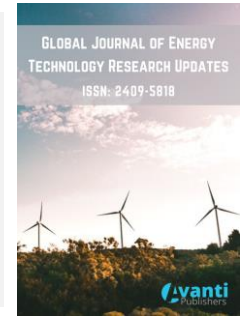

Published by Avanti Publishers  
**Global Journal of Energy Technology  
Research Updates**  
ISSN (online): 2409-5818



## An Assessment Tool for Energy Audit of Buildings in Jordan Using Simulation

Abeer Al-Jbour<sup>1</sup>, Heba Abutayeh<sup>2,\*</sup> and Bashar R. Qawasmeh<sup>3</sup>

<sup>1</sup>PwC | TLS Middle East Risk and Quality, Amman, Jordan

<sup>2</sup>Department of Science and Technology, National University College of Technology, Amman, Jordan

<sup>3</sup>Department of Mechanical Engineering, School of Engineering, The University of Jordan, Amman, Jordan

### ARTICLE INFO

*Article Type:* Research Article

*Academic Editor:* Ahmad Fakharian<sup>1</sup>

*Keywords:*

Energy audit  
Dymola software  
Energy modelling  
Modelica language  
Energy conservation

*Timeline:*

Received: May 04, 2024

Accepted: July 14, 2024

Published: August 14, 2024

*Citation:* Al-Jbour A, Abutayeh H, Qawasmeh BR.. An assessment tool for energy audit of buildings in Jordan using simulation. Glob J Energ Technol Res Updat. 2024; 11: 01-51.

*DOI:* <https://doi.org/10.15377/2409-5818.2024.11.1>

### ABSTRACT

In developed nations, there's a growing concern for sustainable energy management, particularly regarding enhancing energy efficiency in both existing and new buildings. The methodology presented considers the energy modelling and simulation of manufacturing buildings through thermal and electrical loads calculations using Dymola/Modelica software. The thermal model is built with the primary components of Dymola along with available models to calculate the heating and cooling loads, whereas the electrical model was calculated using consumption patterns, then the total model was validated against real measurements where the error percentage was 9.96 %. The yearly heating load baseline was 6295 kWh/y and for cooling 46276 kWh/y., the exciting potential for energy- savings and load flexibility, and some suggestions for improving consumption were pointed out and identified. It found that the highest influence on the thermal load reduction was using the double glaze with shading with 61% of the energy-saving options, then replacing the fluorescent with LED with 30%, and finally, the roof insulation was the least influence with 9.5%. For the total consumption, the highest percentage was for replacing the fluorescent with LED with 78% of energy-saving options, then double glaze with shading, and finally the lowest is for the roof insulation.

\*Corresponding Author

Email: [habutaye@nucl.edu.jo](mailto:habutaye@nucl.edu.jo)

Tel: +(962) 791996040

# 1. Introduction

## 1.1. Research Problem and Goals

Jordan is classified as a non-oil producing country, meaning that it depends on imported energy resources to meet the growing demand for electrical energy, were according to the National Electric Power Company (NEPCO), the purchased electric power in 2022 was 20,763.2 gigawatt-hours compared with 19,618.8 gigawatt-hours in 2021. On the other hand, fossil fuel resources are not stable and not reliable due to political circumstances, which can threaten the continuous supply of these resources alongside with the instability of its prices. This alert for the attention to adopting local strategies that guarantee reliable energy resources to keep up with demand. However, to improve the electricity supply security the government of Jordan has started to search for alternative sources of energy [1], and this would be a burden on the national economy of Jordan.

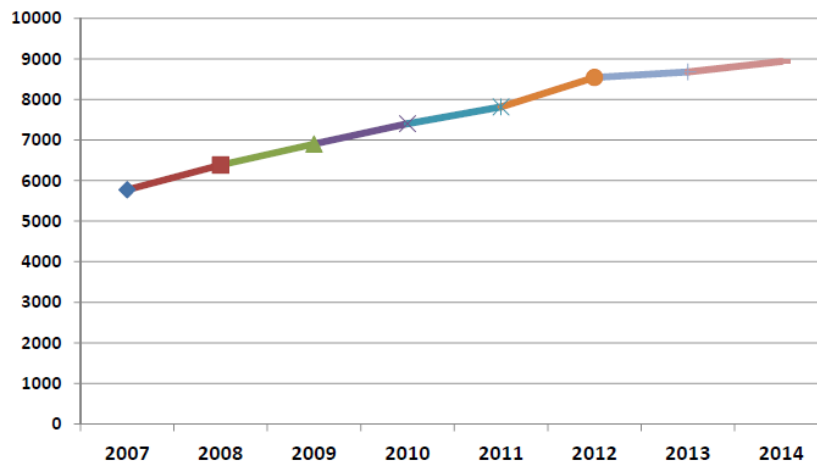

**Figure 1:** Buildings sector consumption of electricity over the last eight years in Jordan (GWh) [2].

Buildings generally (Commercial, Public and Residential) consumes more than 60% of the total electricity consumed in Jordan. Where every facility that consumes more than 50 toe/ year shall carry out an Energy Audit (Fig. 1) [2].

As electricity prices in Jordan increased many times and the fact that energy bill represents 20% of the Jordanian GDP; it affects the most aspects of the Jordanian life. Therefore, the motivation in the country is moving quickly towards the energy-saving buildings to reduce the operating cost of the building [3].

## 1.2. Energy Auditing

There are many relatively similar definitions of an energy audit; such as the Canadian Industry Program for Energy Conservation CIPEC definition of energy auditing is:

“A systematic, documented verification process of objectively obtaining and evaluating energy audit evidence, in conformance with energy audit criteria and followed by communication of results to the client [4].

## 1.3. Using Simulation Programs in Energy Auditing

The key reason for building energy modelling and simulation during or after the energy audit is to understand the building condition and check it against utility bills to reduce the energy consumption of the buildings as a validation process of these simulations. Computer-based modelling and simulation is a proven technique for evaluating building energy consumption, where now there are many simulations software available for whole building performance simulation for example BLAST, DOE 2, eQUEST, TRNSYS, EnergyPlus, Energy Express, EFEN etc. [5].

## 1.4. Research Problem

Energy audit is not a new approach to saving energy and was defined by many previous studies; as a technique for identifying energy losses, quantifying them, estimating conservation potential, evolving technological options for conservation and evaluating techno-economics for the measures suggested. In addition, the objectives of an energy audit are universally accepted but the methodology is not standardized [6].

However, energy auditing may become a time-consuming and expensive process due to efforts required for data collection and detailed information of audited buildings especially when they are large with many details to cover. Adding to that it is not always an easy and quick success job for an energy auditor to identify all of the energy streams in a facility to decide the preferred energy management opportunity that is beneficial.

To improve the energy efficiency of buildings and the effectiveness of energy-saving to assess the heating and cooling energy needs, both energy consumption measurements can be carried out and calculations be used.

The need is increasing to provide a reference that saves time and effort and can be built upon in the field of energy auditing in factories. At this point, dynamic building simulations offer the opportunity to give more details and to achieve results that are more reliable.

## 1.5. Research Goals

The main objective of this study is to develop an assessment decision-making tool through dynamic simulation software in the time course of a calendar year, to be used in energy audit process for manufacturing building in Jordan. In order, to save time, cost, and allow the interested parties of the building to observe a preliminary assessment on opportunities to implement energy-related decisions that would achieve the targets of the audit.

These simulations, which are intended to be constructive modifications to the building as well as system-technical changes of the heat supply and electrical consumption, can be mapped. The heating and cooling requirements in addition to electrical requirements resulting from the different simulation scenarios should be analyzed and evaluated both quantitatively and qualitatively. Based on results should be a first assessment of possible energy-savings be given by these requirements. The simulation model developed is intended to provide for the integration of an energy be expandable system to allow a later investigation of the overall system.

The basis of the dynamic simulation of the thermal loads will be a simulation model, which will be developed using the programming language Modelica in the simulation environment Dymola. This simulation model should take into account the thermal momentum resulting from the building structure as well as thermal interactions with the environment and internal heat loads. In particular, the dynamics of energy demand should be able to be mapped using the resulting heating and cooling energy flows. In addition, energy consumption values of selected periods should be calculated and displayed.

The main novelty of this study lies in two main points: study the energy-saving options of ELREHA Manufacturing Facility plus the study's potential to serve as a reliable and foundational case study applicable to the manufacturing sector in Jordan; it will allow the users to add quickly models for new components, then enabling rapid reconfiguration of components to form new systems compatible with their case studies.

## 2. Literature Review

Thumann *et al.* pointed out that there are four basic types or levels of energy audit in order of increasing complexity: Type 0-The Benchmarking Audit, Type I-The Walk-through Audit, Type II-Standard Audit and Type III-Computer Simulation, where in the fourth level of auditing the auditor will develop a computer simulation of building systems that will account for weather and other variables and predict year-round energy use [7].

Saltelli *et al.* demonstrated that the scientific models in general can be "Diagnostic or Prognostic" and "Law-Driven or Data-Driven". In the Law-Driven (forward) models the system's behavior is predicted given its properties

and conditions, this model is used in building design stage, where Driven (inverse) models work on the opposite approach, using system behavior as a predictor for system properties, this model use monitored data from the building to produce models which are capable of accurately predicting system behavior [8].

Crawley *et al.* provided a comparison of the features and capabilities of twenty major building energy simulation programs, which was based on information provided by the program developers in the categories of: general modeling features; zone loads; building envelope and day lighting and solar; infiltration, ventilation and multi zone airflow; renewable energy systems; electrical systems and equipment; HVAC systems; HVAC equipment; environmental emissions; economic evaluation; climate data availability, results reporting; validation; and user interface, links to other programs, and availability [9].

Lucentini *et al.* proposed an algorithm model which had been applied to the hospitals sector, to estimate all the energy performance indicators (dependent) as a function of a small number of indicators taken (independent) whose estimation is simpler, that made it possible to operate a substantial reduction of energy indicators collected for the evaluation of the energy performance .As illustrated in their study the algorithm was able to provide results, which otherwise would request lengthy and complex calculations and therefore high costs in terms of time and resources used [10].

Keirstead *et al.* presented a theoretical definition of an urban energy system model and evaluated the state of current practice, through drawing on a review of 219 papers, they identified five key areas of practice: technology design, building design, urban climate, systems design, policy assessment and added a sixth one which is land use and transportation modeling. Two of the main four challenges discussed by them were the “complexity of the modeling domain” and “data availability and its quality”. They stated that the levels of complexity in models are countered by the fact that the core assumptions embedded in a model’s architecture will determine how accurate a model will be, where less complexity generally means more assumptions, but if the core assumptions are invalid, then the methodology is of little or no importance [11].

Coakley *et al.* discussed a detailed review of current approaches to model development and calibration, which is defined as reconciling model outputs with measured data where we can achieve accurate and reliable results due to the difficulty to achieve. In addition, they discussed a detailed assessment of the various analytical and highlighted the importance of uncertainty in the calibration process. Moreover, they discussed both the problems and the merits of the presented approaches. they also explained how simulation models may be used to compare the cost-effectiveness of energy conservation measures (ECMs) in the design stage as well as assessing various performance optimization measures during the operational stage [5].

Obara in a study of European project TRIBUTE (2013-2017) aimed to reduce the gap between predicted and measured energy performance of buildings, through the improvement of the prediction capacity of energy modeling and simulation tools. As a further step in the case study, they used to follow real time measurements a deployment of comfort sensors (temperature, humidity, luminosity) in the building and the protocol. Finally, they presented the connection between real time measurements, and the energy simulation model [12].

Wang *et al.* concluded about using whole-building benchmarking method that there are various energy classification schemes available to assess the overall energy-performance of existing buildings. Unfortunately, the systematic multi-level energy performance assessment/diagnosis methods are very limited, and are in practice conducted manually, adding to that based on the lack of generic, effective and user-friendly tools available for practical energy performance assessment and diagnosis are serious limitation for implementing energy enhancement measures in existing buildings. Finally, they recommended to make further research on energy performance assessment of existing buildings to pay more efforts in developing the systematic and effective assessment and diagnosis methods [13].

Dongellini *et al.* in their study presented the results of a preliminary energy audit carried out on 8 large industrial buildings of a famous car manufacturing holding in Italy. they concluded that from all kinds of nonresidential buildings, which have been widely researched; industrial buildings are generally characterized by larger thermal loads, ventilation losses and pollution control requirements, the energy demand for heating varied

from 6 to just over 74 kWh/m<sup>3</sup>year among the buildings of the site. In their study, they built a specific factory energy model through the energy audit, which has been used to analyze the impact of various energy-saving actions on the primary energy consumptions of the site [14].

Traore *et al.* demonstrated in their study that 10% validation error was observed in a simulation of thermal and electrical behavior of a rail station in France. In their models developed in Dymola, two modeling tools were chosen and compared to each other. They were Trnsys and Dymola/Modelica. According to the study Trnsys has advantages and disadvantages, first it is a modular and flexible tool used for solving problems of heat transfer in the building envelope. It contains many libraries of models allowing the evaluation of the building's energy performance. Its disadvantage is that models are mainly focused on the heat phenomena, in the opposite of Dymola (Elmqvist, 1978) which is a multi-disciplinary tool for the detailed resolution of physical problems such as thermal, mechanical, electrical, thermodynamic, hydraulic, pneumatic, and control systems. On the other hand, Dymola provides the possibility of using small-time steps and the equations that describe the behavior of a system are formulated in a declarative way and are automatically resolved. A priori, the computational procedures are not oriented. Considering the advantages and inconveniences of each tool analyzed, according to the authors the Dymola/Modelica was chosen for their modeling work [15].

Wetter had further arguments of the future environment for building system modeling and simulation. He examined in particular the limitations of existing building simulation programs to model and simulate the performance of integrated-building energy, control systems, and how recent advances can overcome these limitations [16].

Ruiz *et al.* discussed in their study that the validation measurements (uncertainty indices), where the measurement of the accuracy of building energy models is an important task, because once the model is validated through a calibration procedure, it can be used, for example, to apply and study different strategies to reduce its energy consumption in maintaining human comfort [17].

Akash *et al.* stated that the industrial sector in Jordan energy consumption represents 22% of the country's total energy consumption. They conducted a survey covering about 10% of the total existing industrial firms, where he indicated that the main sources of energy in the industrial sector are electricity, heavy fuel oil and diesel fuel. They pointed out that in Jordan and in most developing countries as well, energy conservation issues can be discussed, but actions are rarely taken, unfortunately, so it is up to the officials who must begin to implement new programs to improve energy efficiency [18].

Kablan discussed the energy conservation status at the industrial sector in Jordan and outlined some mitigation options for the energy conservation problem. He showed that the share of the industrial sector of the annual final energy consumption of the country is around 23%. Also, he indicated that the management of many companies is not highly encouraged to implement energy conservation projects because they believe that such investments might result in a higher price of their products which might lead to reducing their competitiveness at the local and international markets. Although the Jordanian government has been providing many incentives to promote energy, top management at some other industrial establishments are simply resistant to change because they do not know how to start an energy conservation project and how to implement it effectively. In his research, he proposed a methodology for the systematic implementation of an energy conservation project. As a possible extension of his research, he recommended to convince some industrial establishments to implement the proposed approach for systematic implantation of energy conservation project and monitoring the results over a sufficient time- period [19].

Al-Ghandoor *et al.* studied the prospects of energy-savings in the Jordanian plastic industry; they found that the main improvements made are focused on aspects related to the industry like improvement of the electrical Power Factor of the facility or replacement of energy-inefficient motors. As he listed all the different remedies that can lead to electrical energy conservation, they concluded that the implementation of these recommendations is very crucial for the plastic industry in Jordan. The authors stated that such study could be considered as the corner stone in achieving national energy-savings among all Jordanian industries. Therefore, it is highly recommended to carry out such studies and analyses for other Jordanian industries" [20].

Al-Widyan, *et al.* studied the energy performance of a non-residential service building in Jordan, where a comprehensive energy audit was conducted through which building systems were investigated including the building envelope, HVAC, and lighting systems, where a reduction of 33% is found achievable by implementing common retrofits to the existing building systems. They concluded that in a country like Jordan that relies heavily on imported energy, a substantial potential does exist not only for reducing energy consumption, but also for simultaneously improving the level of human comfort in service buildings. Through he indicated that in non-residential buildings, the envelope, HVAC, and lighting systems make up almost the total energy consumption and thus energy management efforts should focus on them. They concluded also that implementing renewable energy projects (PV systems) could make substantial savings in energy consumption in buildings. Therefore, national incentive programs to this end should be re-examined and expanded [21].

Sharma *et al.* Pointed that the benefit of energy audit reports is establishment of protocols for auditing methods and the standardization of audit reports. These guidelines are primarily shaped by the structure of the audit report itself. These reports must detail energy consumption, costs, major consumption areas, equipment performance, recommended energy-saving strategies, installation costs, and their respective payback periods [22].

Alrwashdeh examined the energy landscape of Jordan, highlighting the country's heavy reliance on imported oil, which constitutes 95% of its energy needs. Jordan's energy consumption has been increasing at an average annual rate of 5%, creating a pressing need for alternative energy sources. The research underscores the significance of renewable energy, particularly solar and wind power, due to Jordan's favorable climatic conditions, with over 320 sunny days annually and suitable wind speeds. The assessment reveals that Jordan has made strides in renewable energy, with solar and wind energy projects contributing to the national grid. However, the study also identifies challenges such as the growing energy demand, high production costs, and grid stability issues. To address these, the research suggests diversifying energy sources, enhancing renewable energy investments, and adopting energy-saving technologies and building practices. The study concludes that leveraging renewable energy and modern technologies is crucial for Jordan to achieve energy security and environmental sustainability [23].

Kuntuarova *et al.* pointed that District heating (DH) systems play a crucial role in reducing greenhouse gas emissions and achieving climate targets. This paper systematically reviews available DH network modeling and simulation tools, focusing on their modeling approaches, application scope, and functional capabilities to assist practitioners in selecting the most appropriate tool for their specific needs. Dymola, a prominent tool in the field, is highlighted for its advanced capabilities in modeling and simulation using the Modelica language. Known for its open libraries and support for both steady-state and dynamic simulations, Dymola allows for user-defined components and real-time simulation, and offers co-simulation through the FMI standard. This flexibility makes Dymola particularly suitable for detailed and integrated modeling of DH networks. A significant portion of the paper is dedicated to comparing various DH simulation tools, including Dymola, TRNSYS, and others. Dymola is noted for its capability to handle dynamic simulations and real-time network analysis, making it a powerful tool for both academic research and practical applications. The paper also discusses open-source Modelica libraries, such as the IBPSA library, which provide comprehensive models for heating, cooling, and energy storage systems [24].

Cucca *et al.* addressed the pressing issue of energy efficiency in the building sector, which significantly impacts greenhouse gas emissions. The authors detail the REMOURBAN H2020 project's pilot deep refurbishment of a small cluster of 10 homes, aiming to achieve near-zero-energy performance at a reasonable cost. The project incorporates energy-saving measures and a hybrid energy-supply system featuring ground source heat pumps, photovoltaic panels, and energy storage devices. The system is designed as a low-temperature district heating system, and its management requires an effective control strategy to optimize energy consumption and minimize running costs. To facilitate this, the authors developed a co-simulation tool combining Dymola-Modelica for the energy system model and EnergyPlus for the building model. This tool helps in devising control strategies to reduce grid energy consumption, maximize photovoltaic energy self-consumption, and transition to sustainable energy resources. The paper highlights the significant role of the building sector in energy demand, accounting for

roughly 40% of energy consumption in the EU and 36% globally. Using the co-simulation tool, the authors evaluated the performance of the retrofitted homes. The results demonstrated significant energy consumption reductions post-refurbishment [25].

Alasmar *et al.* focused on the development of a housing stock model to evaluate energy consumption in Jordan's residential sector. Recognizing that dwellings constitute 72% of buildings and consume 40% of primary energy. The study emphasizes the importance of understanding energy consumption patterns to achieve national energy efficiency goals and reduce environmental impacts, providing policymakers with valuable insights for developing effective strategies [26].

Sandri *et al.* analyzed the sustainability of Jordan's energy sector amidst economic development and regional instability. Jordan's energy security is challenged by its dependency on imported fossil fuels, which constitute 94% of its energy supply and 10% of GDP. The study employs desk research and expert interviews to assess the status quo, challenges, and future aspirations of Jordan's energy sector, emphasizing the need for environmental, economic, social, and political sustainability.

Despite efforts to diversify energy sources, energy security remains critical due to increasing domestic demand (3% annually) and regional conflicts. The study highlights the importance of investing in renewable energy, improving energy efficiency, and fostering synergic agreements with other countries. The study concludes that Jordan must adopt comprehensive strategies addressing energy demand and supply to transition towards sustainable energy security, emphasizing transportation, water conservation, and renewable energy investments [27].

Nagy *et al.* explored the application of reinforcement learning (RL) in optimizing building energy management. They addressed ten key questions ranging from the basics of RL and its promise for buildings to practical deployment challenges and future research directions. RL is positioned as a method to enhance energy flexibility, reduce carbon emissions, and integrate renewable energy sources while maintaining occupant comfort. The authors discuss how RL contrasts with traditional rule-based and model predictive control (MPC) methods, highlighting its adaptability to dynamic environmental conditions and its potential for optimizing complex, multi-objective energy systems. They also emphasize the role of RL in transforming buildings from passive consumers to active grid assets, crucial for achieving energy efficiency and sustainability goals in the built environment [28].

Khan *et al.* provided a thorough examination of tools and models used in designing photovoltaic (PV) systems. It explores the evolution of PV system design over several decades, emphasizing the integration of various tools, models, and heuristics aimed at optimizing PV system configurations. The paper reviews approximately 46 tools, including Dymola, highlighting its role in modeling hybrid energy systems that combine PV arrays with other renewable and non-renewable sources [29].

Muhič *et al.* examined how varying input values of building energy model parameters affect simulation outcomes. The study utilized dynamic simulations in TRNSYS software, encompassing models of three distinct buildings. Parameters investigated included reference dimensions, infiltration rates, envelope thermophysical properties, and thermal capacitance of interior spaces. The findings indicate that the precision of input parameters concerning the thermal properties of glazing has the greatest influence on simulation outcomes. Specifically, reducing the g-value from 0.62 to 0.22 led to a decrease in simulated  $q_{H,nd}$  and  $q_{C,nd}$  by 25% and 95%, respectively [30].

Joshi *et al.* demonstrated that energy usage in manufacturing industries accounts for a significant portion of global energy consumption. In India, industries alone consume nearly half of the total energy used. Energy expenditures typically constitute a substantial portion of a company's operating costs. Industries stand to benefit from opportunities for energy savings through the adoption of effective energy management practices and suitable tools. The simulations with suggested changes show up to an 11% reduction in lighting energy consumption and the potential to lower temperatures from 38°C to 33.23°C. The influence of ambient factors, such as sun exposure, wind directions, and humidity based on geographical location, was also factored into the analysis [31].

Zipplies *et al.* demonstrated that dynamic thermo-hydraulic simulations of district heating networks (DHN) play an important role in exploring innovative designs and operational strategies for energy-saving. Developing solutions for specific case studies necessitates huge long-term simulations, making computational efficiency a serious factor. Heat consumers (HCs), being numerous, significantly influence mass flow dynamics and return temperatures within DHNs. Therefore, the modeling approach for HCs affects both computational requirements and simulation results. Their study introduced a Modelica-based model for HCs, which enhances upon an existing simplified modeling approach. They found that the model improves the calculation of mass flow and return temperatures by ensuring robustness, actual behavior, and efficacy in computational resources [32].

Al Momani *et al.* Pointed that conducting an energy audit (EA) is an important step toward enhancing energy efficiency in factories and achieving certification for cleaner manufacturing practices. Their study presented the findings of a preliminary energy audit conducted at a large industrial facility in Jordan known for producing foods in the Middle East. The energy audit facilitated the development of a factory energy model, which was used to assess the impact of various energy-saving options on the facility's overall energy consumption. They found that improving boiler system efficiency, particularly in diesel consumption, could potentially lead to an 18% reduction in energy consumption. Furthermore, switching from conventional motors to energy-efficient motors is projected to result in long-term cost savings, estimated at approximately 3472.314 JD per month. Additionally, the study identified that the proposed Procedures could help avoid annual emissions of 772.82021 tons of CO<sub>2</sub> [33].

Qiu *et al.* demonstrated that since its concoction with version 1.0 in 1997, the Modelica language has updated to its current version 3.1, it has become the preferred choice for system simulation. Its strengths lie in representing high-level components' behaviors without the need for complicated algebraic equations. Modelica presents diverse modeling methodologies, remains open-source, and empowers users to develop their compilation tools. These advantages have sparked numerous topics concerning the language [34].

Hinkelman *et al.* investigated open-source district cooling models available in the Modelica Buildings Library at the University of Colorado Boulder. Which include six interconnected buildings and a central chiller plant equipped with a waterside economizer. The model was used to study many energy-saving strategies such as optimizing control setpoints, modifying equipment, and adjusting pump setpoints. They found that implementing these strategies in combination could result in annual energy savings of 84.6 MWh, equivalent to an 8.9% reduction in electricity costs and a decrease of 58.0 metric tons in carbon dioxide emissions on campus [35].

Akpahou *et al.* they pointed the importance of effective energy planning in urgent challenges faced by developing nations, such as energy security, economic competitiveness, and climate change mitigation. This study presents a systematic literature review focusing on different energy modeling tools specifically focusing on their significance in shaping the energy landscape of Sub-Saharan African (SSA) countries. They concluded that establishing training programs, workshops, and educational initiatives aimed at reinforcement local expertise in energy modeling across the SSA region can enhance decision-making capabilities [36].

As stated above there were some studies on the industrial sector especially in Jordan, where they concluded about the importance of awareness on the energy consumption patterns and energy awareness in Jordan, plus many studies emphasizes the Importance of Modelica language and its flexibility, so in this study, an assessment decision-making tool is developed through dynamic simulation software Dymola in the time course of a calendar year to be used in energy audit process for manufacturing building in Jordan.

### **3. Case Study: ELREHA Manufacturing Facility**

The studied building in this study is ELREHA Jordan Plant. It is located in Zarqa free zone in Jordan. ELREHA Jordan Plant is an assembly line for previously constructed electronic boards, provided by ELREHA Printed Boards Corporation which has 3 facilities in USA, Germany and Jordan, and electronic components (integrated circuits, transistors, condensers and capacitors... etc.) into fully functioning and tested electronic chips that serve the needs of the customers and the public market.



ELREHA Jordan exists in Zarqa free zone, with a total area is 2000 m<sup>2</sup> and a production area of 1500 m<sup>2</sup>. There are 4 SMT production Lines capable of assembling 20000 shot/hr each, a total of 80000 shot/hr.

The following sections describe the layout and use of the building, the structural design, the technical equipment of the plant and the components of the existing energy supply system.

### 3.1. Building Distribution and Use

ELREHA Jordan plant consists of two main zones; zone (A) and zone (B). Table 1 summaries the breakdown of building areas and their spatial and temporal use.

**Table 1: The building zones and their use.**

Zone	Area	Rooms	Usage Times
A	1485 [m <sup>2</sup> ]	Production area, cafeteria, small offices Bathrooms	Sunday-Thursday 7:30-17:30
B	275 [m <sup>2</sup> ]	Entrance reception, meeting room, offices,	Sunday-Thursday 7:30-17:30

### 3.2. Building Construction

The basic structure of building consists of brick and plaster construction and solid concrete. In the external walls, there is no insulating material. On three of the outer sides, there are continuous rows of window areas in the top of the walls, on the south side there are windows in the form of individual partly in the middle of wall.

The east side has a large roller door. The entire building complex is equipped with a hanger ceiling roof to the outside, it is with congregated aluminum sheets, the inside roof surfaces are gypsum boards.

All windows of the building are single glazed and framed in aluminum, see Fig. (2).



**Figure 2:** Part of windows in production area.

### 3.3. Technical Equipment

The technical equipment of the building includes electrical and machinery work, some appliances and lighting systems.

In the offices of building there are total of 10 active computers, 9 laptops, and 5 printers. The offices have air conditioners. The cafeteria is equipped with a fridge. For the lighting, it is integrated into the ceiling with LED grid lights and Fluorescent.

### 3.4. Machines

Production Line in the plant in zone A consists of 6 basic stages where each stage has a special machine:

1. MPM (Solder paste printer).
2. CP (Chip Shooter).
3. QP (Fine Pitch).
4. SMT Oven (Reflow Oven).
5. Solder Wave Oven.

They are heavy machinery; they work mostly for 5 hours a day, 15 days a month, and are located in Zone A. An outside compressor will be considered in the electrical model.

The following Figs. (3-4) shows the machines in the facility.



**Figure 3:** a) CP (Chip Shooter).

**b)** QP (Fine Pitch).



**Figure 4:** a) SMT Oven (Reflow Oven).

**b)** MBM.

### 3.5. HVAC System

One of the most important factors when investigating the energy efficiency of ELREHA Jordan is the HVAC system. All units were from the same brand (General). Table 2 shows the AC units in the building.

**Table 2: AC units in the building.**

Capacity	Number of AC units	Type
20 Ton	1	Package unit
4 Ton	1	Split unit
2 Ton	8	Split unit

## 4. Methodology

The main objective of this study is to develop an assessment decision-making tool through dynamic simulation using a computer-aided simulation model in the time course of a calendar year to be used in energy audit process for manufacturing building in Jordan, to allow the interested parties of the building to observe a preliminary assessment on opportunities to implement energy-related decisions that would achieve the targets of the audit.

The methodology used in this work follows the following steps:

- 1) Data was collected for energy audit process of ELREHA Jordan plant.

The following are the major types of the building data that will be collected for assessing building energy performance:

- Geometrical Configuration and building footprint.
- Building shell and construction materials.
- Internal loads including occupancy/un-occupancy loads of employees during daytime and after-hours, office equipment, lighting systems and heating and cooling loads.
- Operating schedules including occupancy and after-hour schedules.

The data collection will be done through the stages of energy audit:

- Pre-audit data taken including, Energy bills, Geographical location, weather data, Facility layout, Operation hours and list of equipment as were mentioned above.
  - Walk through to specify visible areas that seem to be the major cause of energy waste, then an evaluation of the practical stage process will be done and the results side by side with those obtained by theoretical track will be used to demonstrate and ensure the correctness of data.
  - End-use energy measurements will be obtained compared with baseline case (standards) for each system in the building.
  - Set primary recommendations based on analysis of data.
- 2) A development of the model for the overall system was carried out with the Dymola simulation tool based on the programming language Modelica, which included the system sub-models, where the focus of this study was on thermal model considering that it is the mutual model between the different industrial fields. The functions, calculation, basics of Modelica and Dymola as well as the modeling process are the contents of the section 5.
  - 3) The electrical model representing the electricity consumption was carried out using calculated model to sum up with the simulated one.

- 4) The thermal model verification will test basic models within constant values and compare them with HAP (Hourly Analysis Program) software results of the same case study.
- 5) To validate the overall model developed in this work the simulation; the heating and cooling requirements plus the calculated electricity consumption model are matched with real measurements taken from the electricity bills in kWh, this will be described thoroughly in the next sections.
- 6) The influence of the chosen parameters was calculated by sensitivity analysis for four different variables to study different energy-saving options.

## 5. Modeling

In this section, the choice of modeling tool is first presented with supporting arguments. Second, the methodology of thermal and electricity loads modeling is described.

The characteristics of the systems that involve multiple domains such as heat and mass transfer, thermodynamics, fluid mechanics, electrical, control and communication systems would require a modeling environment that is suitable to study the behavior of this system.

### 5.1. Modelica and Dymola

Because of its flexibility, Modelica allows several different applications in mechanical, hydraulic, thermodynamic and control technology tasks. The advantage of Modelica is the possibility of programming equations without any order. The solver works iterative and therefore an acausal programming is allowed.

Modelica is an object-orientated programming language that allows the calculation of physical models, which can be written in mathematical equations, collected as well as saved in libraries. A Solver translates these equations to solve this with a mathematical algorithm [37].

To work with Modelica using a graphic editor is needed. The commercial modelling and simulation software Dymola is used, where in this program it is possible to generate graphical models with physically equations, which can be connected to each other by connectors. These connectors transmit different physical conditions, e.g. pressure, temperature, density. In addition, it is also possible to transmit mathematical conditions, e.g. boolean variables [37].

As the programming language Modelica is used for interdisciplinary modeling complex technical systems, it allows implementation variable signal flow directions in universal reusable model their use, the effort of modeling complex overall systems significantly reduced [38].

The Modelica Standard Library includes various reusable model components of different size and complexity and is hierarchical structured in various technical fields. In addition to abstract basic Models for mathematical operators and relations, exist physical replacement models for standardized technical machine or plant components like pumps and pipelines. The specification of the individual model component is done by the individual parameterization of the relevant model parameters based on the characteristics of the real system to be modeled and its technical components. The linking of individual model components to one in the higher-level system model is implemented via so-called connectors. The signal flow of such a connection is for a particular type of variables or a particular physical flow quantity, e.g. Mass flow, heat flow or electric current defined.

### 5.2. Development Environment of the Case Study

The model building and simulation using Modelica takes place in the commercial development environment Dymola. Dymola has a graphical modeling layer that provides the user with visually supported modeling.

In this case, model components and their connections are interconnected to form a so-called object diagram, which graphically represents the physical substitute model of the overall system to be modeled. The underlying mathematical model and the program code are generated automatically [38]. In addition, Dymola has a simulation

level which serves for the translation of the generated program code and the solution of the mathematical equations by means of numerical algorithms. The results as well as all static and dynamic input and output parameters can be output graphically or numerically in the simulation level.

### 5.3. Procedure of the Model Creation

For the creation of the overall model, model components of the Modelica Standard Library and some of the ThermalLoadHC validated models [39] were selected, linked and parameterized. The building weather data including ambient temperature come from the inserted combo tables which is the representation of data which Dymola software works with. ThermalLoadHC validated models are presented in terms of their physical and mathematical background in the following section.

For the building's internal heat sources partial models were created that the loading calculation of electric by people, lighting equipment and other serve equipment and machines within the building produced heat flows and volumes. These sub-models were freely programmed in Modelica.

### 5.4. Constructive Building Elements

The demarcation of thermal zones with each other and the building environment takes place through constructive building elements such as wall, floor and ceiling surfaces. For the modeling of these building elements, the model component Wall model was created. This models the thermal energy transport through a planar and opaque wall construction consisting of several layers of different thickness. In this case, a simplified one-dimensional heat transport is assumed.

The structural elements of the building also include windows and doors. For the modeling of windows, the model component Window was created. The input parameters result from the geometry and radiation properties of the surfaces as well as the design and material properties of the wall or wall. Glass layers. Geometry properties include the total surface area in the form of length and width, the orientation of the surface in terms of the azimuth and tilt angle, and the vertical distance of the lower edge to the ground. The relevant radiation parameters are the absorption and emissivity of both sides. The window model also takes into account the frame portion of the window, the U-values of the glass and the frame, the energy transmittance (U-value), and so on such as a geometric shading coefficient (GSC), with which the shaded portion of a window area can be included.

The output variables are the surface temperatures of both sides. The mathematical model of these model components is based on the accounting of the change in the internal energy of each material layer in combination with the equations of the transient one-dimensional heat conduction for the calculation of the resulting heat flow. The input parameters that are relevant for this calculation are the specific heat capacity of each material layer, the density, the thermal conductivity, the surface dimensions and the thickness of each individual layer. In the model component of the window, the individual glass layers are combined into a single layer of material of appropriate thickness. The thermal conductivity is calculated from the U value.

The building was evaluated based on the thermal behavior of its building interior and its constructive elements which was acquired from building survey, as built documentations, data collected, specifications and drawings.

#### 5.4.1. Geometric Modeling

To create a building model for chosen simulation, a geometric model of the building was created.

The layout of the geometric model or the connectivity of the thermal zones is based on the architectural and the HVAC (heating ventilation air-conditioning) drawings, for simplification the building was considered to be one zone A, where the other zone (B) is unheated/uncooled.

#### 5.4.2. Internal Loads

The types of internal loads considered in the model included human occupants, overhead lighting, task lighting, plug-loads and data centers. The data was collected via surveys.

When defining internal loads for each thermal zone, using simulation allows a user to specify many types of information, e.g. geometric information about the thermal zones in the model, energy consumption for equipment and lighting in the zone. In addition, infiltration methods and day lighting can also be specified in the model, the mentioned also depends on the features of the simulation chosen.

## 5.5. ThermalLoadHC Library

In addition to the Modelica standard library, AC model from ThermalLoadHC verified models [39], in thermal load model was used.

It was specially designed through a research study in Technical University of Hamburg-Institute for Environmental Technology, for building's heating and cooling loads of residential housings in Jordan and will be tuned to the specific variables of the case study. Some equations are linear, and the other depends on the thermodynamic equations [39].

The calculation bases of the model components are based on the thermodynamic equations and requirements for calculation methods for building and plant simulation.

Fig. (5) shows the structure of Dymola consisting of so-called packages. Each package includes special model components.

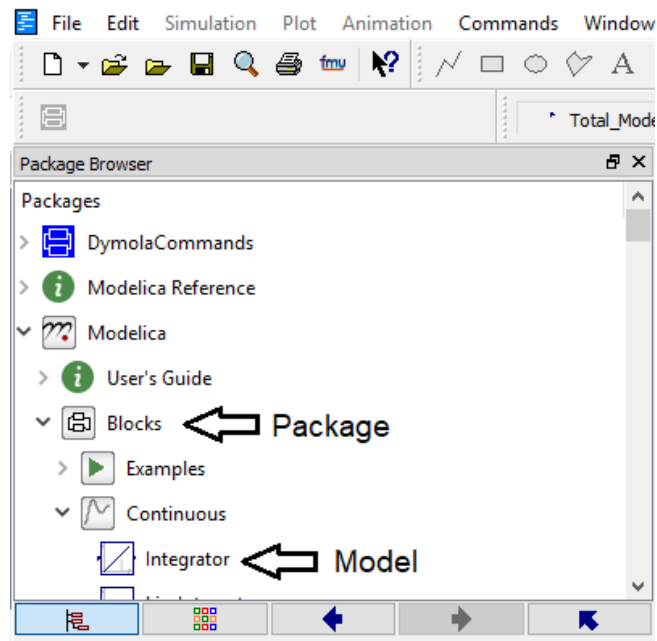

**Figure 5:** Structure of Dymola consisting packages and Models.

## 5.6. Procedure of Modeling

### 5.6.1. Thermal Model

For the creation of the thermal model the components of the Modelica Standard Library and the AC model from [39] were selected, linked and parameterized the thermal model developed is based on elementary components of Modelica combined with AC model depending on thermodynamics equations. The thermal behavior of ELREHA Jordan plant building is analyzed depending on several factors shown as input signals: weather data, air infiltration and ventilation and internal gains.

On the other hand, outputs that are indoor temperatures are used to carry out a closed loop control for the heating power as a function of temperature set points and comfort level. The internal gains are calculated using occupancy profiles of building according to working schedules.

For the modeling of the building, there were 2 zones considered as listed before; one is zone A which is heated and the other is zone B which is unheated. The building construction was freely modeled based on thermodynamic equations and Modelica language, the ambient components along with the solar radiation information was inserted in combo files. All are presented in terms of their physical and mathematical background in the following section.

For the building's internal heat sources partial models were created that the loading calculation by people, lighting equipment, machines and other serve equipment within the building produced heat flows and volumes. These sub-models were freely programmed in Modelica.

### 5.6.2. AC model

This model was assessed from [39] verified models, as he concluded the function of the Air Conditioning-Model is to adapt the room temperature inside predetermined interval. Which contains heating in the winter period and cooling in the summer time. This model also has the function to summarize the total heating and cooling loads for a given period and to calculate the temporary peaks. This model consists of two layers, the upper one where all the models are connected and the lower one that includes the basic models. The Air Conditioning-Model is shown in Fig. (6).

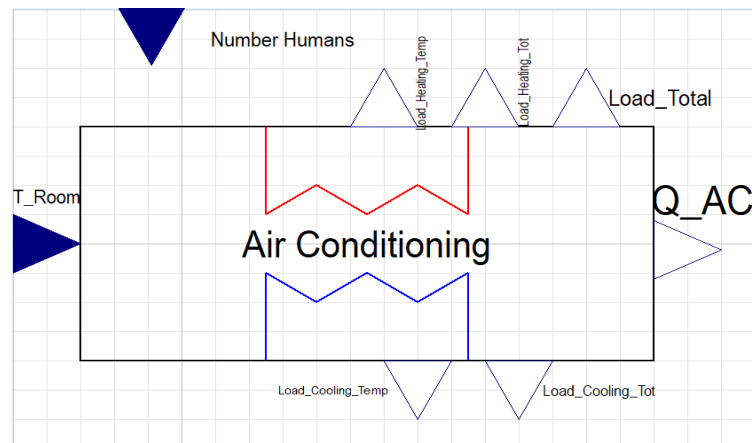

**Figure 6:** Air conditioning-model.

The regulation of the Air Conditioning System. In addition, when to analyze different Boolean cases, which turn the system on or off. For this regulation, four different models were used from the Modelica-Standard-Library. The Air Conditioning is controlled by two conditions:

- room temperature,
- number of humans in the residence,

Other sub-models related to the thermal model will be presented in next section.

### 5.6.3. Electrical Model

Electrical model was calculated on a sheet based on time schedules and power rating of the lighting, machines and equipment, taking into account the working days over a time course of one year, this model was combined with the thermal model to sum-up the overall consumption.

## 6. Modeling of the Overall System

This section describes the presentation of the developed overall model and the partial models contained, focusing on the thermal model as it is the one to be simulated. In the first part of this section, the structure of the building model and the functions of the developed part models are described. Following the parameterization of

the overall model for the baseline scenario of validation is presented. Fig. (7) shows the graphical representation of the overall thermal model in Dymola.

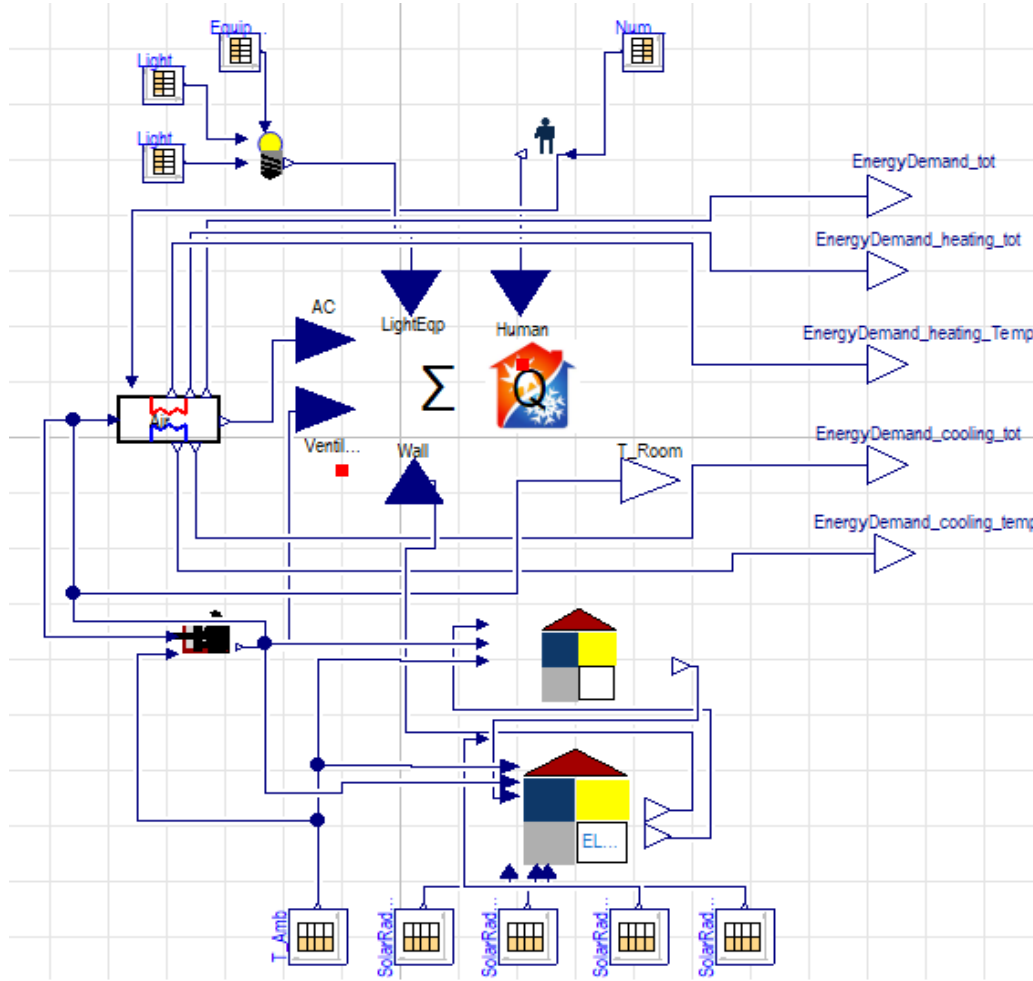

**Figure 7:** Graphical representation of the overall thermal model in Dymola.

### 6.1. Thermal Model

**Indoor Climate:** Regarding the indoor environment, the two main parameters of the indoor climate, the temperature parameters of the heating and cooling limits and the air exchange rate, so in order to follow the equations for achieving the required temperature; the ambient temperature of Zarqa is inserted as well as the solar radiation for 2018.

#### 6.1.1. Summarize-Model

to calculate the heat flows in and out of the building, equation 6.1 balance all heat flows, which occur in a building from thermodynamic equations, as illustrated by [39] there are two different spaces, the Control Room and the Ambient Conditions, where control room could be defined as equivalent to the one zone of a building. In this study, the condition is to consider the Control Room as one zone, therefore no single rooms have to be calculated and the air conditions are homogeneous.

An open and non-stationary system the following equation can be estimated:

$$\dot{Q}_{LigEquip} + \dot{Q}_{Hum} + \dot{Q}_{AC} + \dot{Q}_{Vent} + \dot{Q}_{SR} + \dot{Q}_{HT} = CR \cdot \frac{dTR}{dt} \tag{6.1}$$



Where:  $\dot{Q}_{LigEquip}$  Heat flow due to lighting and electrical appliances and machines,

$\dot{Q}_{Hum}$ : Heat flow due to humans,

$\dot{Q}_{AC}$ : Heat flow due to air conditioning,

$\dot{Q}_{Vent}$ : Heat flow due to ventilation,

$\dot{Q}_{SR}$ : Heat flow due to solar radiation,

$\dot{Q}_{HT}$ : Heat flow due to heat transfer,

CR:  $\frac{dT_R}{dt}$  Change of the control room energy.

The summarized model's main function is to bring all the heat flows together. As shown in Fig. (8), there are five blue connectors that work as an input of the single heat flows. The model has one white connector that is an output and transmits the value  $T_{Room}$ .

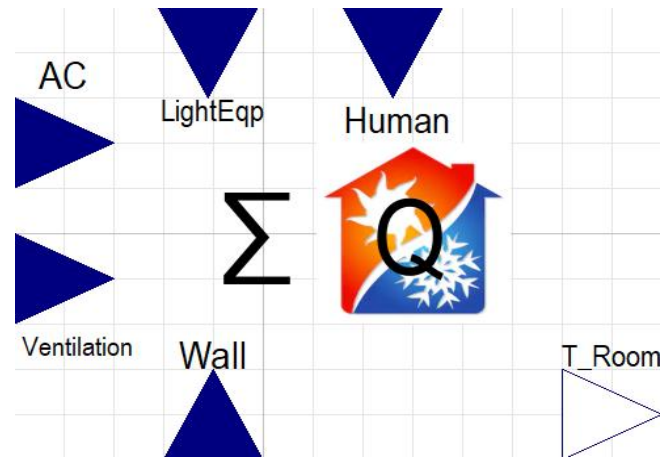

**Figure 8:** Summarized model.

In equation 6.1, the influence of the change in velocity and change of height will not be estimated and is considered negligible so it will not take place in the simulation. The specific equation for the single energy flows that is the main equation of this model is the following:

$$CR \cdot \frac{dT_R}{dt} = \dot{Q}_{LigEquip} + \dot{Q}_{Hum} + \dot{Q}_{AC} + \dot{Q}_{Vent} + \dot{Q}_{Wall} \quad (6.2)$$

Where  $\dot{Q}_{Wall}$  is Heat flow due to heat transfer through wall and window.

$$CR = \rho_{Air} \cdot V_R \cdot cp \quad (6.3)$$

Including:

CR: Room air heat capacitance,

$\rho_{Air}$ : Density of the air,

$V_R$ : Volume of the room,

cp :Specific heat capacity.

The heat flows  $\dot{Q}_{SR}$  and  $\dot{Q}_{HT}$  from equation 6.1 are summarized in the model Wall and the resulting heat flow of this model is called  $\dot{Q}_{Wall}$ . Tables 4 and 5 show the possibilities of parametrization and the chosen values of the constants.

**Table 4: Parameters of the summarize-model.**

Parameter	Unit	Description
l	[m]	Length of the room
w	[m]	Width of the room
h	[m]	Height of the room

**Table 5: Constants of the summarize-model.**

Constant	Value	Unit	Description
cp	1005	$\frac{J}{kg.K}$	Specific heat capacity of air at 20°C
$\rho_{Air}$	1.204	$\frac{kg}{m^3}$	Density of air at 20°C and 1.013 bar

**6.1.2. Lighting Equipment and Machines-Model**

With Lighting Equipment and machines-Model the heat flow due to lighting and electrical equipment and machines are calculated. This model considers two different types of lighting that are mainly available in the building:

- fluorescent tube lamps,
- LEDs.

The model is shown in Fig. (9) and works as a heat source. All equipment and machines are located inside of the control room and generate heat.

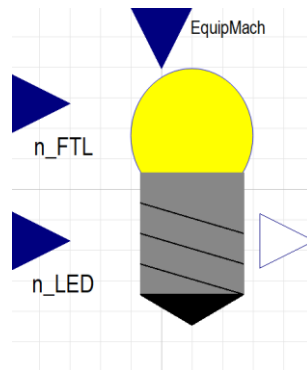

**Figure 9: Lighting-Model.**

The main equation of this model is the following:

$$\dot{Q}_{LigEquip} = \dot{Q}_{Lig} + \dot{Q}_{EquipMach} \tag{6.4}$$

Where:

$\dot{Q}_{LigEquip}$  : Heat flow due to lighting and electrical equipment and machines,

$\dot{Q}_{Lig}$  : Heat flow due to lighting,

$\dot{Q}_{EquipMach}$  : Heat flow due to electrical equipment and machines

The equation to calculate the parameter  $\dot{Q}_{Lig}$  is shown below.

$$\dot{Q}_{Lig} = (\eta_{FLT} \cdot P_{FLT} \cdot n_{FLT}) + (\eta_{LED} \cdot P_{LED} \cdot n_{LED}) \quad (6.5)$$

Where:

$P_{FLT}$ : Electrical power of the fluorescent tube lamps

$n_{FLT}$ : Number of fluorescent tube lamps

$\eta_{FLT}$ : Efficiency of fluorescent tube lamps

$P_{LED}$ : Electrical power of the LEDs

$n_{LED}$ : Number of LEDs

$\eta_{LED}$ : Efficiency of LEDs

The heat flow of any type of lighting is the result of the total electricity power of each lamp multiplied number of lamps, which will be transformed into heat.

The heat flow of the electrical equipment and machines is integrated by an external table, so no parametrization has to be made.

This model includes three inputs and one output. The inputs represent the numbers of the different types of lighting and the heat flow due to electrical equipment and machines. The use of the lamps is not constant and depends on the working hours. It is a function of time; therefore, it is necessary to insert the operation time of the lights and the numbers. How this input value looks like is shown in Fig. (10).

One specific example of the heat flow due to electrical equipment and machines in a working day in ELREHA is shown in Fig. (11). The calculations of heat flow are calculated before they are inserted to the table file.

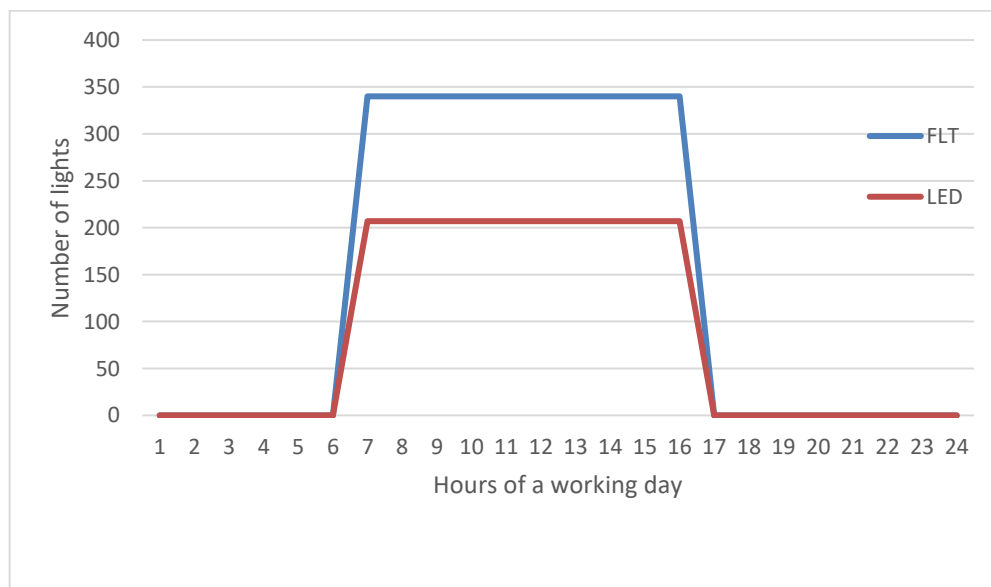

**Figure 10:** Number of lights in a working Period in ELREHA typical day.

The output signal is  $\dot{Q}_{LigEquip}$ , this value is connected with the input connector of the Summarize-Model.

This model has a set of parameters, shown in the following Table 6. The values are based on the collected data, and to simplify the calculation, the electrical power per type of lamp is considered as heat flow.

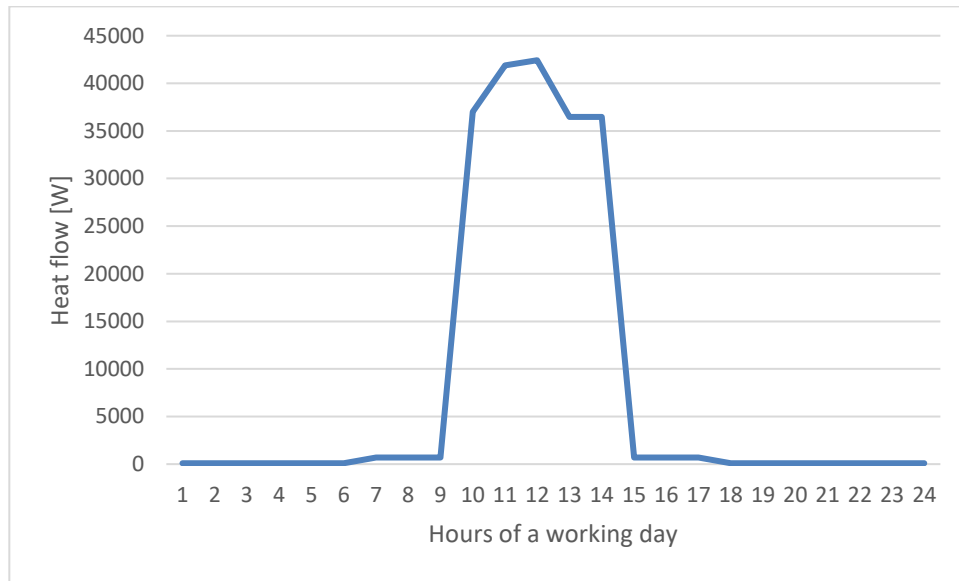

Figure 11: Heat flow due to electrical equipment and machines in ELREHA typical day.

Table 6: Parameters of the lighting-model.

Parameter	Value	Unit	Description
$P_{FLT}$	32	[W]	Electrical power of the Fluorescent Tube lamps
$P_{LED}$	20	[W]	Electrical power of the LEDs

6.1.3. Human-Model

The Human-Model represents the heat flow due to humans. Every human emits heat that influences the air conditioning of the building. This model is shown in Fig. (12).

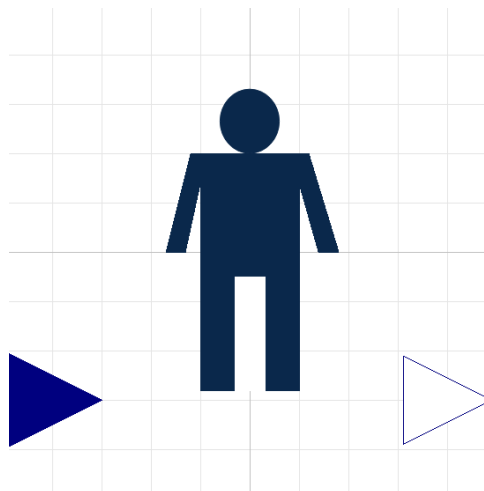

Figure 12: Human-Model.

The main equation of the human-model is shown below (6.6). This formula is commonly used and is referenced in [40]. This calculation considers sensible and latent heat gains of the inhabitants.

$$\dot{Q}_{Hum} = N \cdot ((\dot{Q}_S \times CLF) + \dot{Q}_L) \tag{6.6}$$

Where:

$\dot{Q}_{Hum}$  : Heat flow due to humans

$N$  : Number of humans in one residence

$\dot{Q}_s$ : Sensible heat gain

$CLF$ : Cooling Load Factor

$\dot{Q}_L$  : Latent heat gain

Sensible heat gain is the heat transfer caused by the body temperature and latent heat gain is influenced by evaporation of liquids (e.g. sweat). The Cooling Load Factor considers different aspects of the human behavior (attendance, movements, etc.).

As ELREHA has certain working type the parameters, they are shown in the Table 7 below and the chosen values.

**Table 7: Parameters of the human-model.**

Parameter	Value	Unit	Description
$\dot{Q}_s$	80*	[W]	Sensible heat gain per person
$\dot{Q}_L$	140*	[W]	Latent heat flow per person
CLF	0.89**	-	Cooling Load Factor

\* (Al-Saad et al., 2011) Table 4.2 page 149 [40]

\*\* (Al-Saad et al., 2011) Table page 150 [40]

The model consists of two connectors, an input and an output. The input-connector transmits the  $N$ -value that is the number of people in the building at certain time, as the working hours are fixed and number of employees also, it is considered to have fixed number per month.

The number of people in ELREHA in the selected calendar year is shown in Fig. (13). The result of this calculation is the heat flow due to humans, which is transmitted by the output-connector to the Summarize-Model.

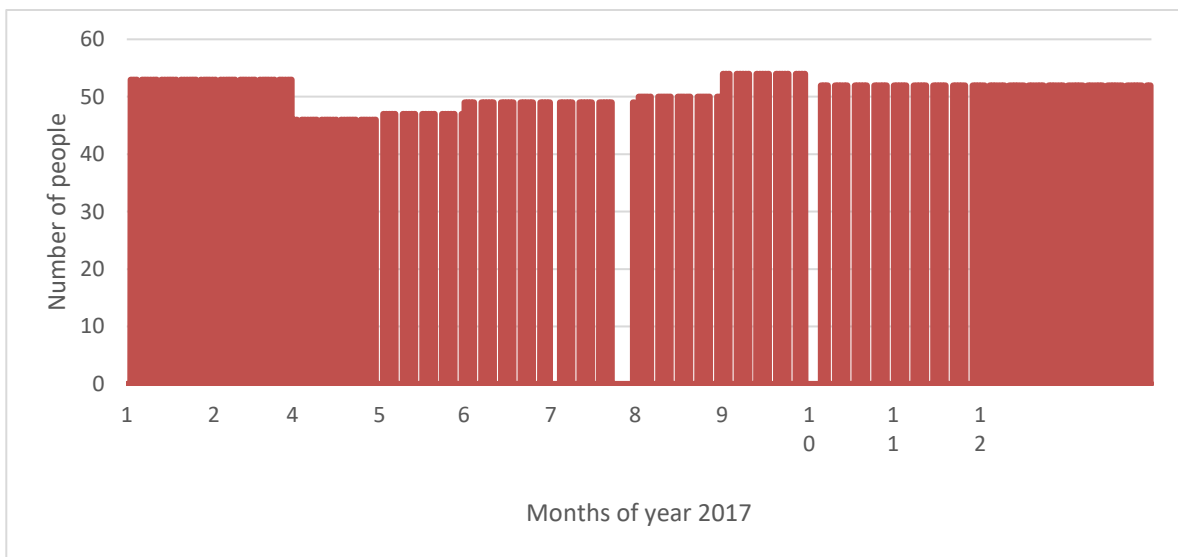

**Figure 13:** Monthly distribution of people in ELREHA.

#### 6.1.4. Air Conditioning-Model

As illustrated, the function of the Air Conditioning-Model is to adapt the room temperature inside of a predetermined interval. That contains heating in the winter period and cooling in the summer time. This model also has the function to summarize the total heating and cooling loads for a given period and to calculate the temporary peaks. It was adapted from [39] with a little adjustment to fit the case study parameters. In the parametrization section the values will be added to the total model, the explanation of each component of this model is out of this study scope, but the concept of it is that the signal-flow goes from the left to the right side. In this model, the heating and cooling circuits are connected in parallel, the heating path above and the cooling below. To generate a single output both strings have to be added in the model named HeatFlowTot. The value of the number of humans is given by a boundary condition.

##### 6.1.4.1. Heating and Cooling Limits

The heating limit is the room temperature, which may not be exceeded during the heating season in winter. The room temperature must not be exceeded is called cooling limit analogously. The modeled heating and cooling limits differ depending on the thermal zone, they are chosen in the AC model

For the heating limits the thermal zones time dependencies of the time of day and day of the week have been modeled, to reflect a decrease in temperature of the heating limit outside working hours, at night and on weekends.

The air conditioning whole connection diagram is shown in [39].

#### 6.1.5. Ventilation-Model

This model is created for calculating the heat flow due to air exchange; it is shown in Fig. (14).

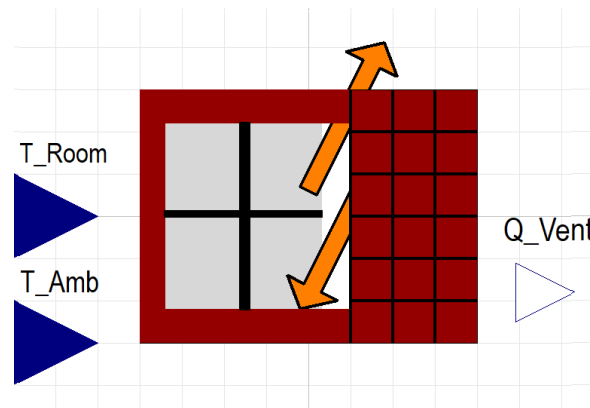

**Figure 14:** Ventilation-Model.

The main equation can be seen below:

$$\dot{Q}_{\text{Vent}} = N \cdot V_{\text{Room}} \cdot \rho_{\text{Air}} \cdot c_p \cdot (T_{\text{Amb}} - T_{\text{Room}}) \quad (6.7)$$

Where:

$\dot{Q}_{\text{Vent}}$  : Heat flow due to ventilation

$N$  : Air exchange rate

$V_{\text{Room}}$  : Volume of the room

$\rho_{\text{Air}}$  : Density of air

$c_p$  : Specific heat capacity of air

$T_{Amb}$  : Ambient temperature

$T_{Room}$  : Room temperature

This equation is based on the first law of thermodynamics and is used in several papers to calculate the heat flow due to ventilation. This model consists of three connectors (two inputs and one output). The temperatures have to be integrated as external conditions. The input  $T_{Room}$  is connected with the output of the Summarize-Model, the value  $T_{Amb}$  is given by boundary conditions. This model calculates the variable  $Q_{Vent}$  that is also connected with the Summarize-Model.

Table 8 shows, which default parameters have to be set and Table 9 presents the chosen constants. The selection of the ventilation rate is based on the common numbers.

#### 6.1.5.1. Air Exchange Rates

The air exchange rate is the second main parameter of the room climate model. For the air-change rate of the thermal zones of the outside temperature can be varied depending on the time of day and day of the week as well.

In view of the temporal dependencies were so-as weekday and weekend, differentiated to reflect the varying air exchange due to the presence or absence of people between day and night.

**Table 8: Parameters of the ventilation-model.**

Parameter	Unit	Description
N	[-]	Air exchange rate
l	[m]	Length of the room
w	[m]	Width of the room
h	[m]	Hight of the room

**Table 9: Constants of the ventilation-model.**

Constant	Value	Unit	Description
cp	1005	[J/kg.K]	Specific heat capacity of air at 20°C
$\rho_{Air}$	1.204	[kg/m <sup>3</sup> ]	Density of air at 20°C and 1.013 bar

#### 6.1.6. Wall-Model

This section is about the Wall-Model, which calculates the heat flow  $Q_{Wall}$  and will introduce the several layers and sub-models. The model is shown in Fig. (15) as well as the Model-Layers of the ELREHA Wall-Model in Fig. (16).

When building the wall model for ELREHA, there are more than one model depending on the construction, there are 3 main areas considered, first the main heated zone (Zone A) and second the unheated zone (Zone B) and last the ceiling as it is hanger ceiling and has its own temperature due to air gap.

There are 3 external walls (North, East, West) and one internal wall for the heated zone from the south, where the next zone has 3 external sides and one internal from the south, the area of each zone will be inserted in the parameterization section as seen in Fig. (17).

As shown in Fig. (16) there are four different models on the second level:

- Internal Wall Heat Exchange-Model
- External Wall Heat Exchange-Model

- Ceiling Heat Exchange-Model
- Roof Heat Exchange-Model

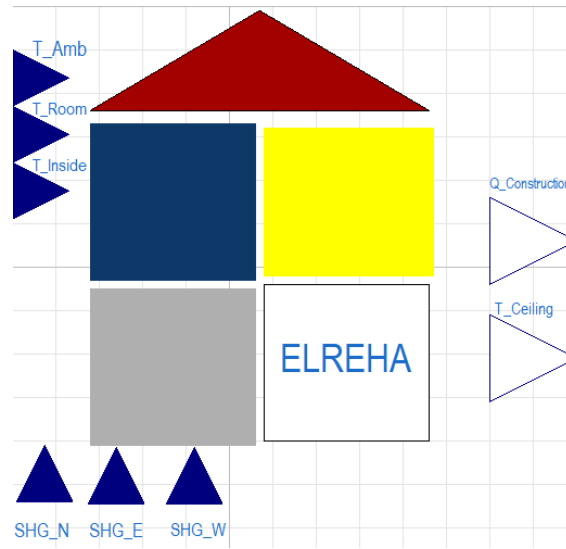

Figure 15: Wall-Model.

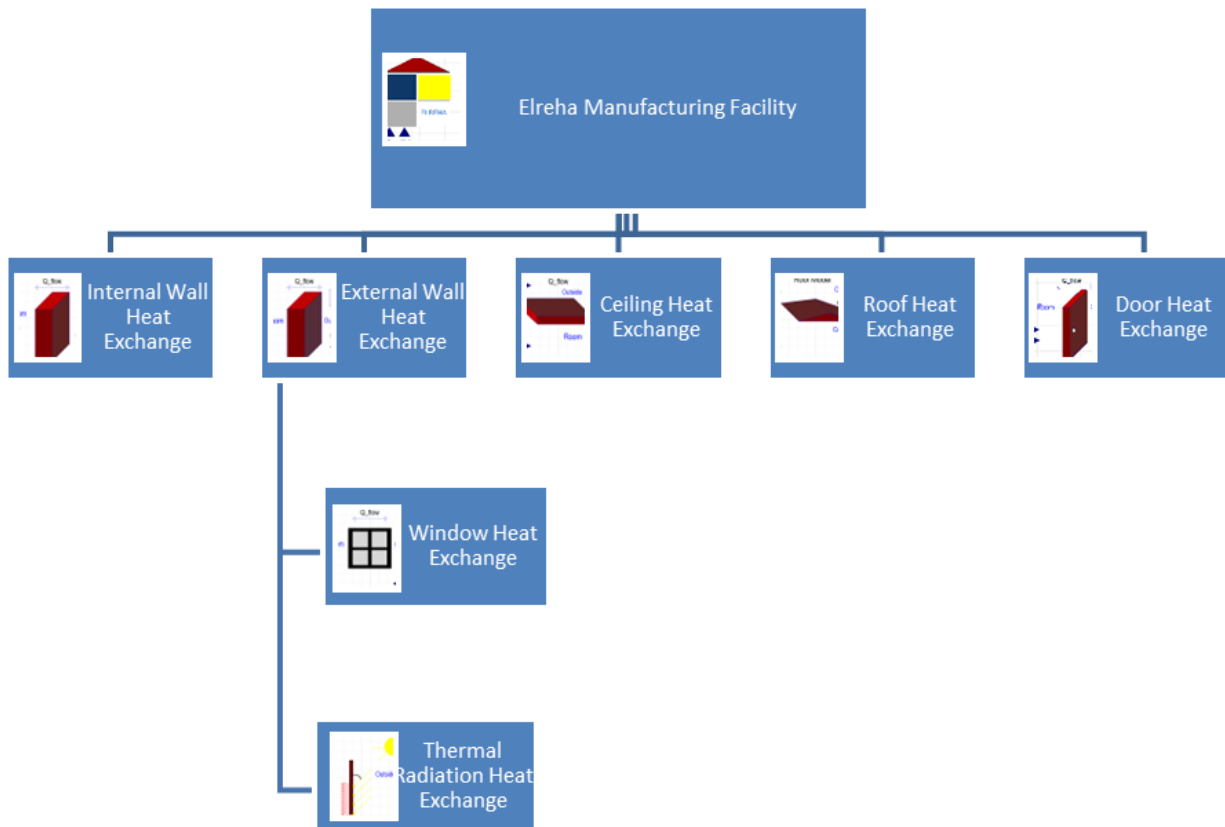
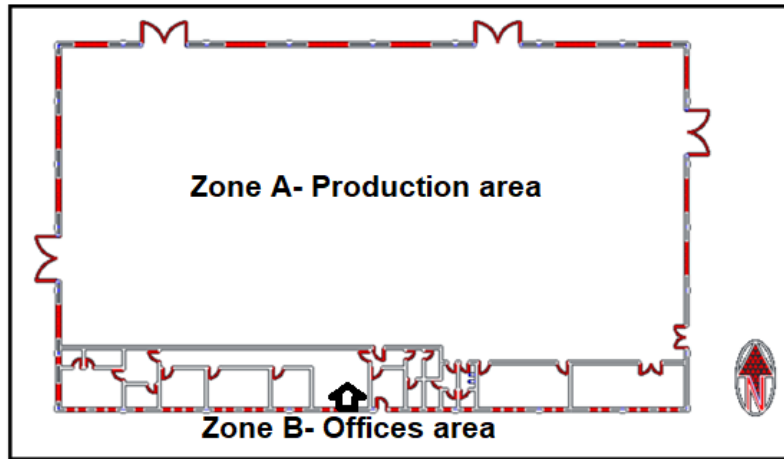

Figure 16: Model-layers of the ELREHA wall-model.

All the above Heat Exchange-Models are based on the same principle of thermal conduction through a solid material. They calculate the heat flow with the same main equation. Therefore, in the next section the Wall Heat Exchange-Model will be explained that will be applied to them all.

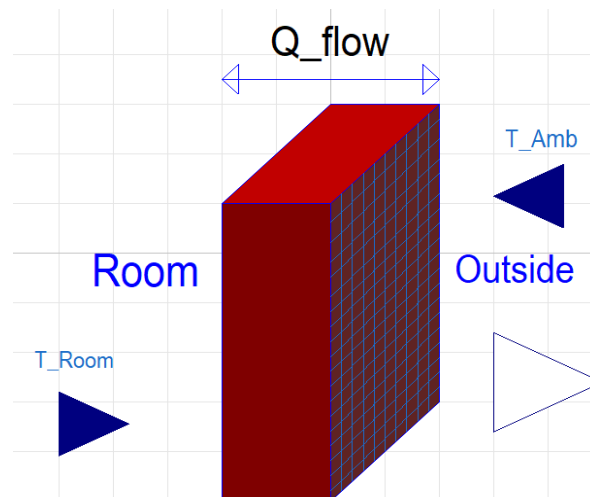



**Figure 17:** ELREHA building zones.

#### 6.1.6.1. Wall Heat Exchange

This Wall Heat Exchange-Model simulates the heat flow through a solid material and the main equation 6.8. The model is presented in Fig. (18).



**Figure 18:** Wall Heat Exchange-Model.

$$\dot{Q}_{\text{Wall}} = U_{\text{total}} \cdot A \cdot (T_{\text{Amb}} - T_{\text{Room}}) \quad (6.8)$$

Where:

$\dot{Q}_{\text{Wall}}$ : Heat flow due to heat transfer through a wall

$U_{\text{total}}$ : Overall coefficient of heat transfer

$A$ : Area of the external wall

$T_{\text{Amb}}$ : Ambient temperature and

$T_{\text{Room}}$ : Room temperature

To calculate the heat flow through a wall it is necessary to know the coefficient of heat transfer. This coefficient inserted as a parameter depending on the wall construction and thermal resistance of each layer. This structure of wall-layer in ELREHA is listed in the parametrization section.

The main equation 6.8 and the equation to calculate the parameter U are based on the thermodynamic behavior. They follow the same procedure used in programs that calculates heat flow like HAP.

6.1.6.2. Window Heat Exchange and Door Heat Exchange

The models Window Heat Exchange and Door Heat Exchange calculate the heat flow through windows and doors. Both models are based on the same thermodynamic behavior as equation 6.9 and 6.10 illustrates. The heat flow due to solar radiation contains the model Solar Radiation, as shown in the following section. The model regarding the heat transfer through a window can be seen in Fig. (19) as well as the door model 6.15.

$$\dot{Q}_{\text{Wind}} = U_{\text{Wind}} \cdot A_{\text{Wind}} \cdot (T_{\text{Amb}} - T_{\text{Room}}) \tag{6.9}$$

Where:

$\dot{Q}_{\text{Wind}}$  : Heat flow due to heat transfer through the window

$U_{\text{Wind}}$ : Coefficient of heat transfer

$A_{\text{Wind}}$ : Area of the Window

$T_{\text{Amb}}$ : Ambient temperature and

$T_{\text{Room}}$ : Room temperature

$$\dot{Q}_{\text{Door}} = U_{\text{Door}} \cdot A_{\text{Door}} \cdot (T_{\text{Amb}} - T_{\text{Room}}) \tag{6.10}$$

Where:

$\dot{Q}_{\text{Door}}$ : Heat flow due to heat transfer through the door

$U_{\text{Door}}$ : Coefficient of heat transfer

$A_{\text{Door}}$ : Area of the door,

$T_{\text{Amb}}$ : Ambient temperature and

$T_{\text{Room}}$ : Room temperature

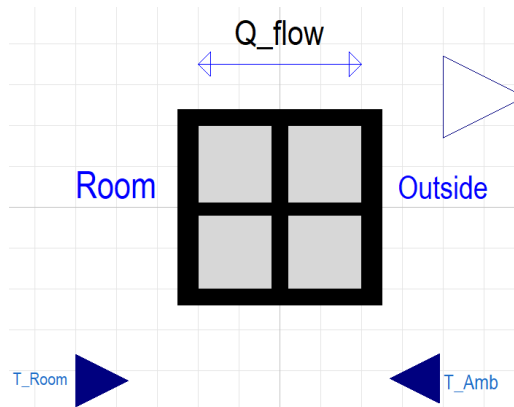

**Figure 19:** Window Heat Exchange-Model.

These formulas are based on the rules of thermodynamics and therefore they are similar to equation 6.8. In comparison, there is only one value for the coefficient of heat transfer and this depends only on the type of window or door, and it does not need to be calculated as a total U value.

All of these models contain two input connectors for both temperatures, where the Ambient Temperature is a given boundary condition, and the Room Temperature is a parameter calculated in the Summarize-Model.

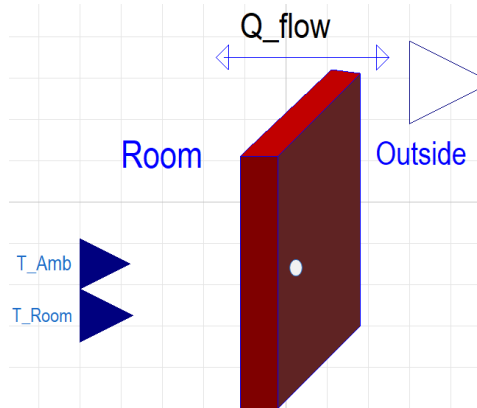
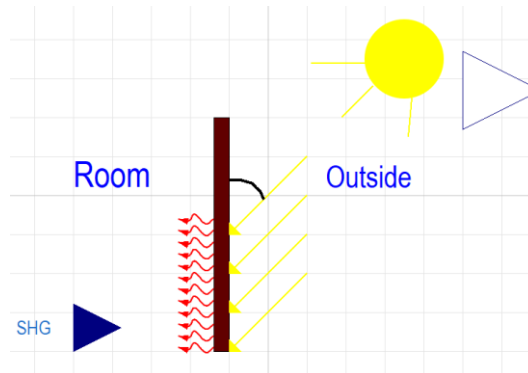

**Figure 20:** Door Heat Exchange-Model.

The parameters are inserted in the parametrization. The results of these models are transferred by the output connector. The equivalent U-value of the window depends on the direction which is faced and are for single-glazing windows, in ELREHA it is single-glazing windows.

#### 6.1.6.3. Solar Radiation

The Solar Radiation-Model calculates the heat flow through a window due to solar radiation. This model is shown in Fig. (21) and represented by equation 6.11.



**Figure 21:** Solar Radiation-Model.

$$\dot{Q}_{SR} = A_{Wind} \cdot SHG \cdot SC \cdot CLF \quad (6.11)$$

Where:

$Q_{SR}$ : Heat flow due to solar radiation through the window

$A_{Wind}$ : Area of the window

SHG: Solar heat gain

SC: Shading coefficient and

CLF: Cooling load factor

This model consists of one input and output. The Solar Heat Gain is given as an external value. The result of this model is the heat flow due to solar radiation and is transmitted by the output connector. The parameters to calculate the value are shown in Table 10. As [41] concluded; the values for SC and CLF depend on the orientation of the façades and time of day. For simplification, constant values were chosen.

**Table 10: Parameters of the solar radiation-model.**

Parameter	Value	Unit	Description
SC	0.2*	-	Shading coefficient
CLF	0.21**	-	Cooling load factor
$l_{Wind}$	-	[m]	Length of the window
$h_{Wind}$	-	[m]	Height of the window

\* (Al-Saad et al., 2011) Tabel 9.8 page 366 [40]

\*\* (Al-Saad et al., 2011) Tabel 9.10 page 367 [40]

**6.1.7. Internal Wall Heat Exchange and Ceiling Heat Exchange**

The other two of the three models of the second layer of ELREHA-Wall-Model are the Internal Wall Heat Exchange-Model and the Ceiling Heat Exchange-Model Both models will be introduced in this section, because they are based on the same principle.

To simplify this simulation the Internal Wall Heat Exchange-Model is equal to the Wall Heat Exchange-Model. Therefore, the same conditions are valid as seen in the previous section. The Following assumption for the Internal Wall Heat Exchange is made; the heat transfer though the internal door is neglected, This Internal Wall-Model calculates the heat transfer between the neighboring unheated area and the heated one. Thus, the Outside-connector transfers the inside temperature not the ambient temperature conditions.

The Ceiling Heat Exchange-Model changes a little bit compared to the Wall Heat Exchange-Model. This is based on the different layers of the ceiling structure. The main equation stays the same, based on the ceiling and roof layers with a gap between them a model that combines them is created to calculate the  $T_{Ceiling}$ , the model can be seen in Figs. (22-23).

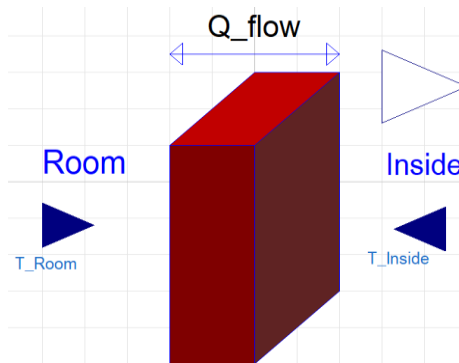

**Figure 22:** Internal wall Heat Exchange-Model.

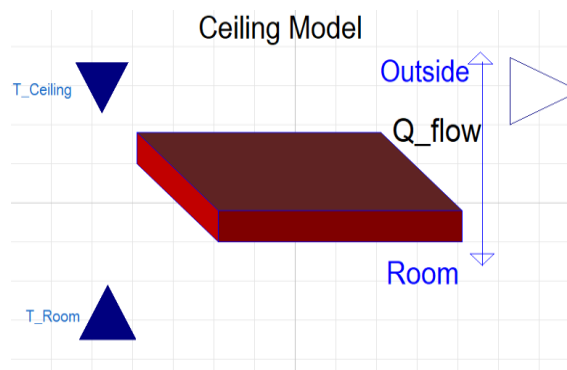

**Figure 23:** Ceiling Heat Exchange-Model.

### 6.1.8. Roof Heat Exchange

The Roof Heat Exchange-Model changes a little bit compared to the Ceiling Heat Exchange-Model. This is based on the different layers of the roof structure. The main equation stays the same, based on the ceiling and roof layers with a gap between them a model that combines them is created with the calculated the  $T_{\text{Ceiling}}$  and the difference is between  $T_{\text{Ceiling}}$  and  $T_{\text{Amb}}$ , the model can be seen in Fig. (24).

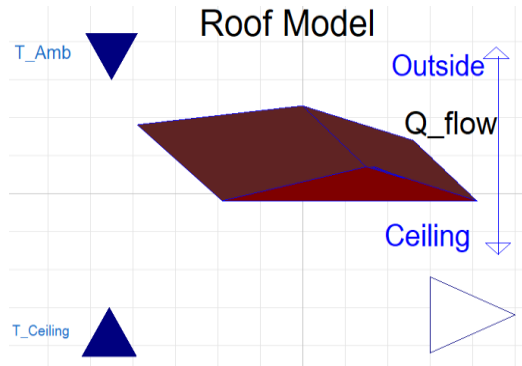

**Figure 24:** Roof Heat Exchange-Model.

The total wall model consists of summation of heat flow through all of construction layers for each part by Sum-Model. Where, there are input connectors and one output representing the total output, three main areas are considered where the need to  $T_{\text{ceiling}}$  for the Roof zone and  $T_{\text{inside}}$  for the unheated area from the south, they all depend on the main equation in the summarized model and sum up to give the  $T_{\text{Room}}$  and total load. The input ones transfer the boundary conditions to the sub-models. The connection-diagram of this model can be seen in appendix A.2.

### 6.2. ELREHA-Wall-Model

This section is about the ELREHA-Wall-Model that represents the highest level of the Wall-Model (Fig. 16). All heat flows through the external and internal walls as well as the roof are added to the output value  $Q_{\text{Wall}}$ .

### 6.3. ELREHA Total Thermal Model

This section is about the final Manufacturing-Model that represents the Energy Flow Chart. The arranged models in the simulation as was illustrated before in Fig. (7).

This model calculates the heating and cooling loads of the facility. The model consists additional of five outputs. The transmitted parameters are:

- load total
- heating load total
- heating load temporary
- cooling load total
- cooling load temporary

All parameters are given in the sub-models of the facility. Therefore, no additional values have to be set. Boundary conditions are integrated by the CombiTimetable-Models, which allow connecting external Editor or Matlab files inside of the simulation.

### 6.4. Electrical Model

The electrical model is the calculation of electricity consumption based on working hours of the lighting, office equipment and electrical machines. It is simply done by the information of each machine multiplied by the

efficiency and finally the working hours, for a time course of a year, it is considered as fixed values that are not affected by dynamic behavior or circumstances. These calculations then added to the AC electricity consumption from simulated model, to be validated against measured data from electricity bills.

## 6.5. Parameterization of Thermal Model

This section describes the parameters of the sub-models and the total model. The parameterised model overall is the so-called baseline scenario and serves as the reference scenario for all simulations about the validation of the model is to have particular regard to the origin of the parameter values.

### 6.5.1. Building Model

Building data regarding used. The dimensions of all components come from the building plan and other information provided by ELREHA facility staff. Table 11 provides an overview of the parameter values of the area volume and treble for each individual thermal zone and the glass surfaces divided by geographic orientation, 3 walls are external (North, east, west) and one is internal (south).

**Table 11: Parameter values for air volume, height and glass surface of the thermal zones.**

Zone	Air Volume [m <sup>3</sup> ]	Height [m]	Glass Surface [m <sup>2</sup> ]			
			North	South	East	West
A	4603.5	3.1	8	0	4	8
B	852.5	3.1	0	15	0	0

Tables 12 and 13, show the numbers, thicknesses and materials of the implemented wall, floor and roof layers as well as the resulting U-values.

**Table 12: Parameter values for windows.**

Window	Parameter Value	Unit
U-value single glass with aluminum frame	5.6*	W / K m <sup>2</sup>

\* (Al-Saad *et al.*, 2011) Tabel 5.4 page 184 [40]

**Table 13: Parameter values of the structural building elements.**

	Number of Layers	Thickness [m]	Material	U-Value [W / K m <sup>2</sup> ]
Outside walls	3	- 0.02 0.15 0.02 -	External Plaster Brick Plaster Internal	2.75
Inside wall	3	- 0.02 0.1 0.02 -	Internal Plaster Brick Plaster Internal	2.68
Inside ceiling	1	- 0.015 -	Internal Gypsum board Internal Ceiling	2.99
Top Roof	2	- 0.01 0.004 -	Internal Ceiling Foam Aluminium External	2.38

Part of the parameter values derived from information provided by the ELREHA contact persons. The parameter values of the layer thicknesses and materials are actual data taken from the facility data. The material properties calculations were made by thermodynamic equations.

The parameter values of the installed in the building window were taken from the technical data sheet.

### 6.5.2. Heating and Cooling Limits

In terms of heating and cooling limits, the following is the case:

- The working days are from Sunday till Thursday (7:30 AM to 5:30 PM)
- Zone A, representing the production area is the used zone, where in Zone B the offices and meeting room are mostly unused
- In Zone A, a room temperature of 24°C is set during the working times, based on the preferred room temperature for human comfort
- Maximum heat flow heating: 95100 W, maximum heat flow cooling 68850 W

In addition to these data, the following assumptions were made:

- The heating season will start on 01/09 and ends at 01/04
- The cooling season will start on 2/4 and ends at 31/8
- Operation of AC only with human in the facility
- In addition, it is assumed that the AC depending on the required temperature and gains will turn on or off

The cooling period means the period in which a switch on the air conditioning is possible if the indoor and outdoor temperatures so require. During the months of April, September and October heating and cooling period overlap.

Fig. 25 shows the ambient temperature of Zarqa where the facility is located.

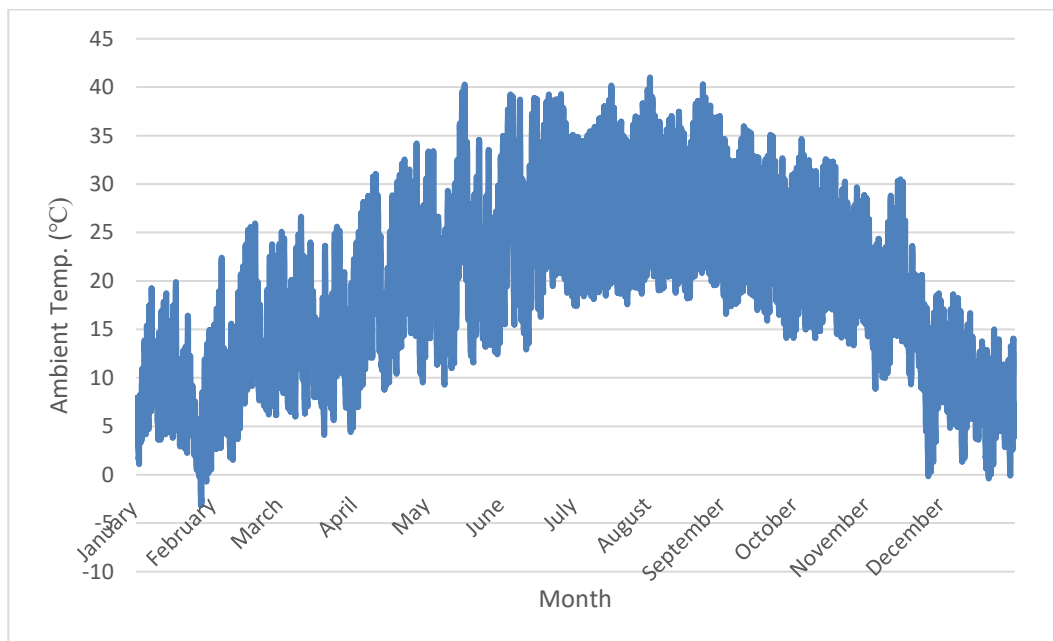

**Figure 25:** Average Ambient Temperature of Zarqa 2014 ([https://www.renewables.ninja\[43\]](https://www.renewables.ninja[43])).

### 6.5.3. Air Exchange

The Air exchange is assumed 1.5. The parameter values of air exchange rates are based on those recommended in practice values and minimum air change rates.

### 6.5.4. The People

The people statistics are as shown in Fig. (13) in the human model previously, and is in average 52, they have normal working activities, and mostly available during working hours in Zone A of the production area.

### 6.5.5. Lighting and Electrical Equipment and Machines

For lighting there is the following lights in the production area in Table 14, they are used for almost all working hours (6 hours a day) as the manufacturing area has no natural lights in Zone A.

**Table 14: Lighting of ELREHA Zone A.**

Light	Number of Lights	Light Power (W)	Hours of Use / Day
fluorescent light	340	32	6
LED lamp	207	20	6

For the electrical equipment and machines in Zone A, the following Tables 15 and 16 show them.

**Table 15: Electrical equipment.**

Device Name	Number	Device Power (W)	Hours of Use / Day
Computer	10	480	8
Laptop	9	70	8
Printer	5	508	2
Fridge	2	150	24

The device dissipated power from office and other equipment reference from ASHRAE Handbook [42].

**Table 16: Electrical machines.**

Machine Name	Number	Machine Power (W)	Motor Efficiency	Hours of Use / Day
MPM	1	350	0.55	5
CP	2	13000	0.9	5
QP	1	5000	0.8	5
Solder Iron	20	95	0.35	2

The Machine powers is taken from the name plate on each one and the heat dissipated regarding these machines are calculated due to the Equation 6.12 [40] as follows:

$$\dot{Q}_M = \frac{P}{\eta_M} (F_U F_L) \quad (6.12)$$

Where;

P: is the power rated of the motor

$\eta_M$ : is the efficiency of the motor



FU: is the use factor and

FL: is the load factor

## 7. Verification and Validation

This section deals with the verification of basic models and validation of a completely developed model simulation. The definitions of verification and validation according to [44] are:

**Verification:** checking, if the mathematical equations of the (physical) models are programmed correctly, and

**Validation:** checking the accuracy of the mathematical models compared to the reality for the given user capabilities.

To achieve a good reproduction of reality following steps will be taken.

1. The verification will test basic models within constant values and compare them with HAP software results of the same case study.

The models specially programmed which work as a heat source (humans, lighting and electrical applications (machines and equipment)) will not be checked because they are independent of the dynamic behaviour of the simulation. They are based on simple linear equations that can be solved exactly and are not a function of the room temperature; therefore, they can be seen as constant inputs, these sub-models are not verified in detail.

The models that have heat flows, which depend on the temperature difference of (Room and Ambient) and will be verified, based on constant values are:

- wall
- ceiling and floor
- door
- window (heat flow ratio)
- Ventilatio.

The Air Conditioning-model already will be carried out as part of the development of it and is not part of this work, but the considered by the validation of the whole system.

2. To validate the overall model developed in this work the simulation; the heating and cooling requirements plus the calculated electricity consumption are matched with real measurements taken from the electricity bills in kWh.

### 7.1. Verification of the Heat Transfer and Ventilation Models

This section is about the verification of all components, which transmit a heat flow because of a temperature difference. The heating and cooling loads of the walls, ceiling, floor, door, windows and ventilation will be checked with the simulation of the same case study on HAP, so the temperature boundary conditions (for heating and cooling) were made constant based on the sessional temperatures in the verification model to check if the mathematical equations of the physical models are programmed correctly, in both Dymola and HAP, they were assumptions that applied to both programs to be able to compare the output and check the deviation.

The simulation tool HAP (Hourly Analysis Program) was used which is based on the ASHRAE calculation (American Society of Heating, Refrigerating and Air-Conditioning Engineers). It was done through two validation models, one for the heating in winter and the other for the cooling in the summer, where each model was

compared to maximum load the is resulted from HAP, taking into consideration the constant values of the linear models of human, lighting and electrical machines to reflect the same conditions.

Fig. (26) represents the verification of the cooling model where the boundary conditions are:

- $T_{Room} = 20\text{ }^{\circ}\text{C}$
- $T_{amb} = 36\text{ }^{\circ}\text{C}$
- Construction of building (volume and U values) are inserted as in the parametrization.

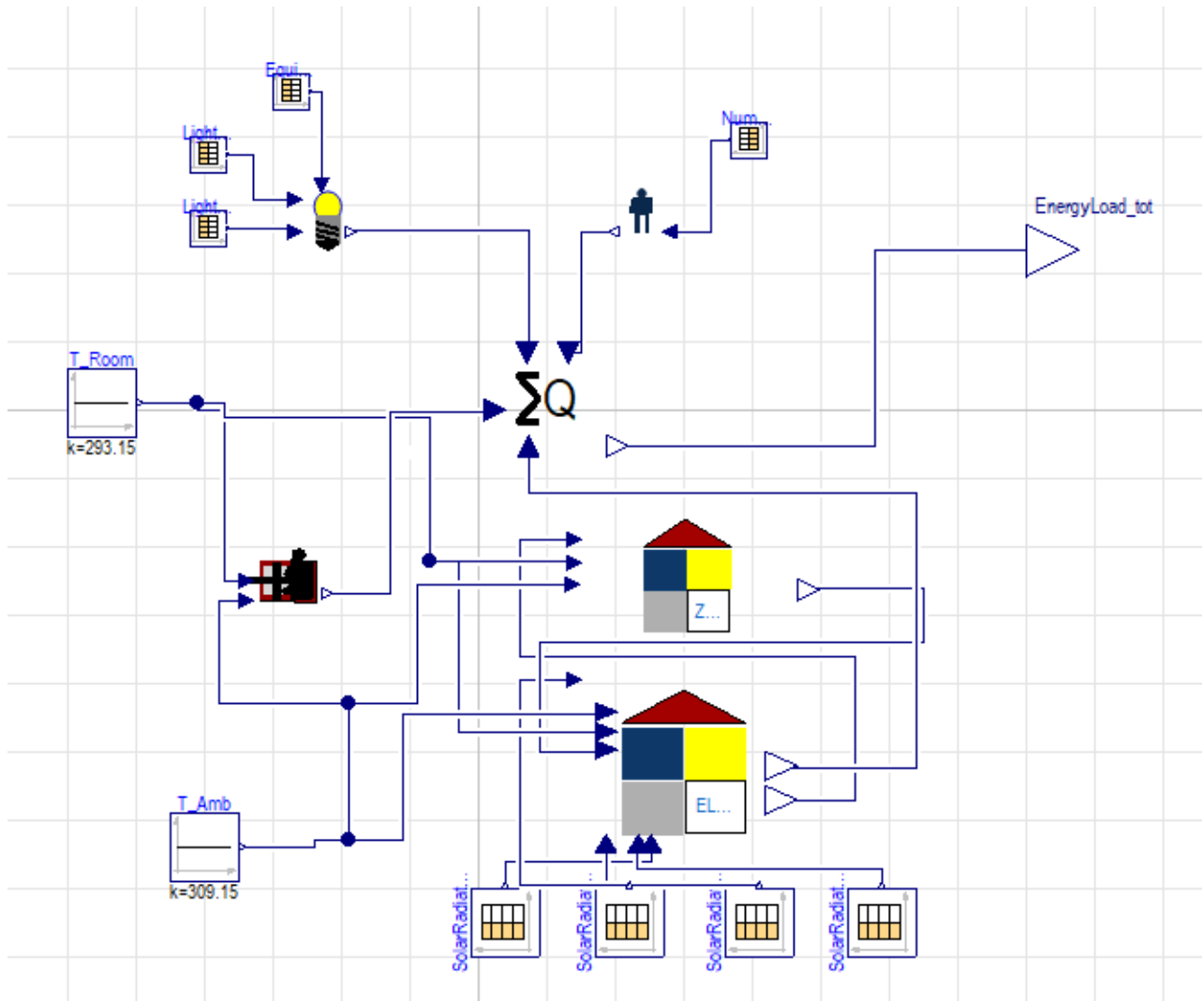
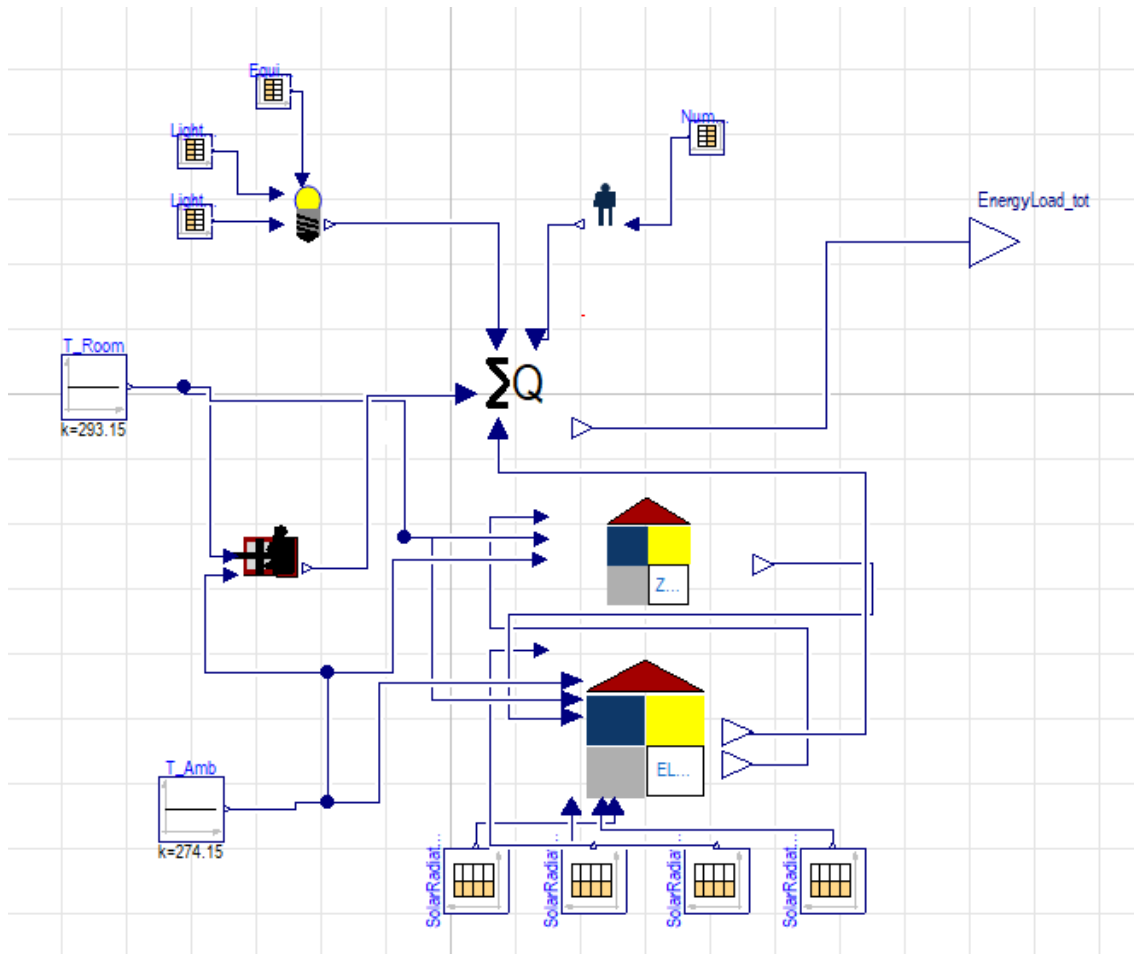

**Figure 26:** Verification of Cooling load in summer.

Fig. (27) represents the verification of the heating model where the boundary conditions are:

- $T_{Room} = 20\text{ }^{\circ}\text{C}$
- $T_{amb} = 1\text{ }^{\circ}\text{C}$
- Construction of building (volume and U values) are inserted as in the parametrization.

The calculation was done for Zone A (heated).



**Figure 27:** Verification of heating load in winter.

Table 17 shows the geometric conditions and the calculation results for the whole building in HAP. Only the heat flows between the ambient and the room conditions are considered thus the external walls. It is assumed that the heated zone has the same temperature.

**Table 17: Yearly Heat flows of case study heated zone calculated by HAP.**

Cooling Load	126,705 (W)
Heating Load	55,293 (W)

It could be seen from Table 18 at the deviation of the total heat flow between the HAP and Dymola simulation is less than 0.7%. This small difference between both results can be caused by the calculation steps of each solver. Possibly the internal round-off error, which is influenced by the tolerance and the step width of the intervals, are the reasons for this deviation (Fig. 28).

**Table 18: Heat flow comparison between the HAP and Dymola simulation.**

Zone Period	HAP (W)	Dymola (W)
Winter	55293	56492
Summer	126705	126738
Total	181998	183230

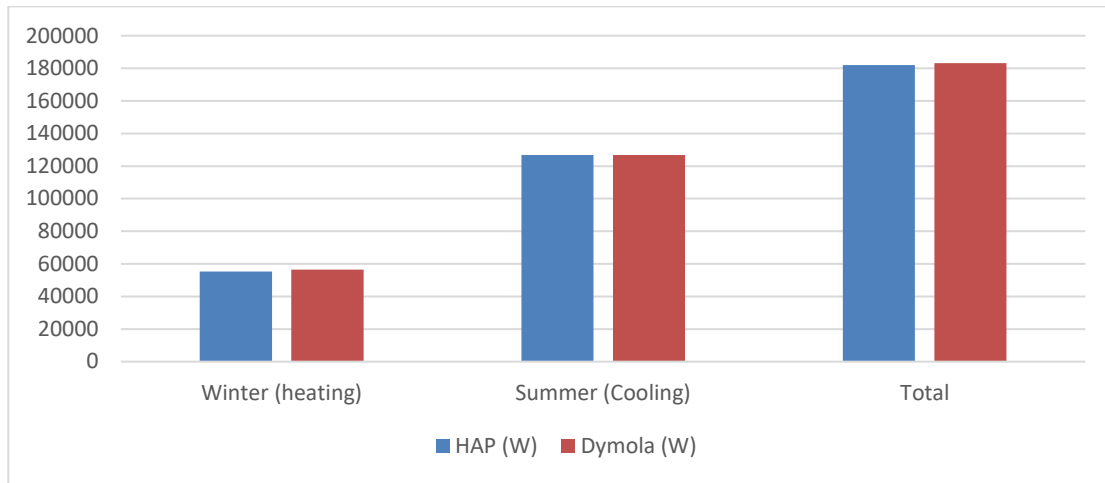

**Figure 28:** Heat flow comparison between HAP and Dymola simulations.

### 7.2. ELREHA Facility Model Validation

This section contains the validation of the whole ELREHA facility Model from section 6.5. To validate the developed model, the monthly heating and cooling requirements of the building were simulated based on the results presented in section 6.5 in addition to the calculated electrical consumption for the reference period from 01.3.2017 until 28.02.2018. Subsequently, the simulation results were compared with measured values from the reference period. In Table 19, the simulated energy requirements are compared to the total electricity consumption from heating and cooling of the building and other consumption in kWh, the sensed demands of the reference months.

**Table 19: Measured values and simulated monthly energy demands of the building for the reference period (March 2017/Feb 2018).**

Month	Measurement [kWh]	Simulation [kWh]
Jan-18	14917	15291.20
Feb-18	17992	16750.22
Mar-17	15487	16468.68
Apr-17	16877	20487.75
May-17	18766	21590.33
Jun-17	19784	21393.02
Jul-17	16946	23981.34
Aug-17	24958	23424.97
Sep-17	19787	21491.14
Oct-17	17679	21166.45
Nov-17	17679	16311.58
Dec-17	9310	12761.87
Total	210182	231118.55

The absolute and relative monthly variations of the simulation results with respect to the measurement results are shown in Table 20.

The absolute difference between the simulation results and the measurement results in a range of 3610.75 kWh in April and 7035.34 kWh in July. The relative deviation varies from 2.51% in January to 41.52% in July. The value from the monthly measurements' energy requirements for the entire reference period is 210182 kWh.

**Table 20: Absolute and relative deviation of the simulation results of the measurements**

Month	Absolute Deviation [kWh]	Relative Deviation [%]
Jan-18	374.20	2.51%
Feb-18	-1241.78	-6.90%
Mar-17	981.68	6.34%
Apr-17	3610.75	21.39%
May-17	2824.33	15.05%
Jun-17	1609.02	8.13%
Jul-17	7035.34	41.52%
Aug-17	-1533.03	-6.14%
Sep-17	1704.14	8.61%
Oct-17	3487.45	19.73%
Nov-17	-1367.42	-7.73%
Dec-17	3451.87	37.08%
Total	20936.55	9.96%

The simulation results show a total energy consumption of 49824.47 kWh for the heating and cooling, adding the electrical calculated model will sum up to 231118.55 kWh, which corresponds to an absolute deviation of 20936.55 kWh. Based on measurement results from a relative deviation of 9.96% for the total energy consumption of the building.

In Figs. (29-30) the simulation and measurement results of the heating and cooling energy requirements for the individual reference month and the resulting energy needs of the entire reference period are compared graphically.

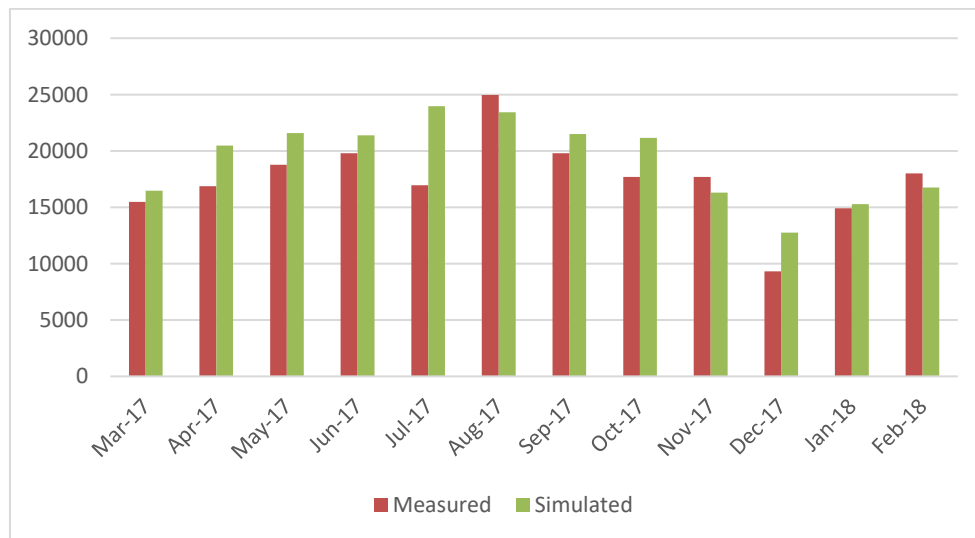

**Figure 29:** Comparison of measured and simulated monthly of the reference period.

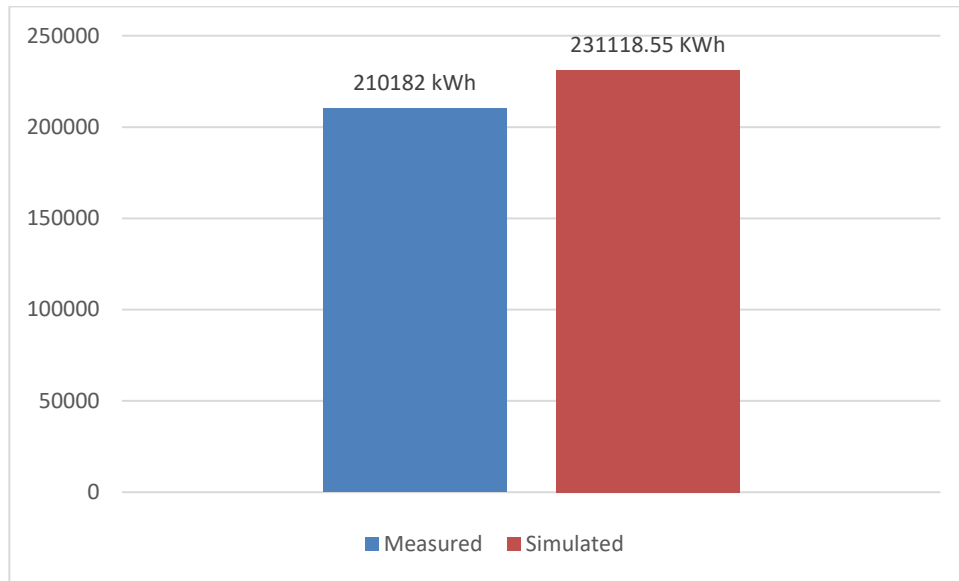

**Figure 30:** Comparison of measured and simulated consumption for the entire reference period.

To put the simulation results and validating the model evaluated in the following section, a sensitivity analysis is carried out based on the selected parameter variations. The parameterization of the model in section 6.5 further illustrates the initial scenario (baseline). The simulated heating and cooling energy requirements of this scenario are used as reference values of the following sensitivity analysis, as the electrical loads are considered as constant added to the model.

Fig. (31) shows the balance of the electricity consumption for simulation results.

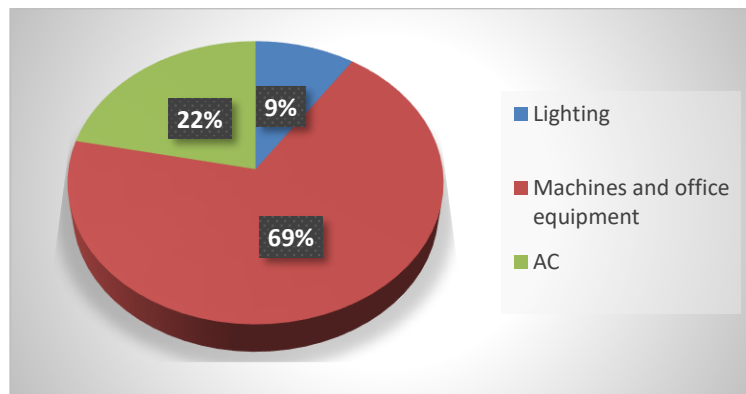

**Figure 31:** Load Balance according to simulation.

## 8. Sensitivity Analysis and Energy-Savings

### 8.1. Sensitivity Analysis

In this section, the influence of various model parameters is analysed for the thermal model of heating and cooling energy loads. The sensitivity of the model in relation to the variation of the selected parameter is analysed to Figure out the most influential parameter on the model. Based on the results of the performed validation of the model to be evaluated.

In the process of performing the sensitivity analysis; a single model parameter is varied, and examined its influence on the simulation results, while keeping all other parameters constant. This process is repeated for each

parameter to be tested, so that for each parameter a specific sensitivity can be examined.

The following parameters will be analysed:

1. Heating and cooling limits.
2. Air exchange
3. People's heat.
4. Windows area.

The heating and cooling limits variation will be made by changing the temperature for defined intervals of  $\Delta T = \pm 2$  K, for the other parameters the initial values will be increased and decreased by a variation of  $\pm 30\%$ ,  $\pm 20\%$  and  $\pm 15\%$  respectively.

## 8.2. Energy-Savings

In this section, the main part of the energy audit is considered based on the reference scenario; it will contain passive and active methods that will influence the load and eventually result in energy-savings, these are common proposals for recommendations through energy audits.

In general, Energy is saved when the heat exchange between the building and the outside environment is reduced and/or solar and internal heat gains are controlled [7].

The analyzed energy-savings options are the following:

1. Replacing single glaze windows to double glaze
2. Add shading to windows
3. Adding Roof insulation
4. Replace fluorescent lights with LED lights

In case of replacing single glaze to double glaze windows the U- value would be changed accordingly from  $5.6 \text{ W/m}^2\cdot\text{K}$  to  $3.2 \text{ W/m}^2\cdot\text{K}$  well as the Shading coefficient (SC) will be 0.9 [42]. Shading on the windows will reduce the solar radiation through the windows; this will be in the summer season.

For the third energy-saving option, a layer of Rockwool would be added with thickness of 0.1 m, this would lower the U-value of the external roof. The last option is the common energy audit option; which is replacing the fluorescent lights with LED lights; this will affect both thermal and electrical models. Finally, a combination of more than one option will be made to Figure out the highest saving percentage scenario among these options.

## 9. Results and Sensitivity Analysis

This section contains the presentation and analysis of different scenarios. Based on the validation and parametrization of the previous sections, the energy loads are calculated. Then several possibilities for the reduction of thermal loads and some electrical loads are simulated. The results and discussion will be for the modeling of the assessment tool; containing sensitivity analysis and energy-saving options.

### 9.1. Modeling Results

#### 9.1.1. Modeling of ELREHA Manufacturing Facility

The plots of August, concerning the heat flow and energy can be seen in Figs. (32 and 33).

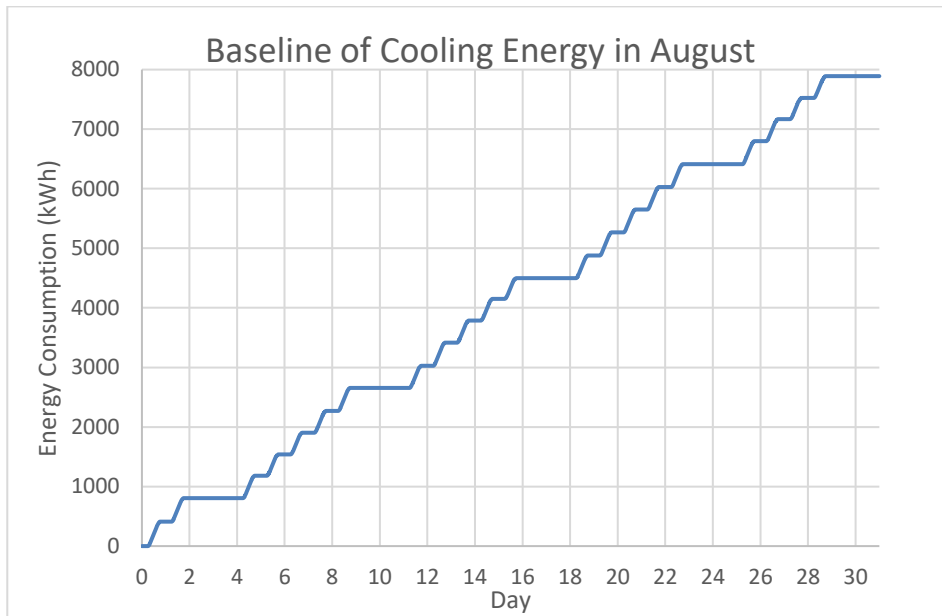

Figure 32: Baseline of cooling energy in August.

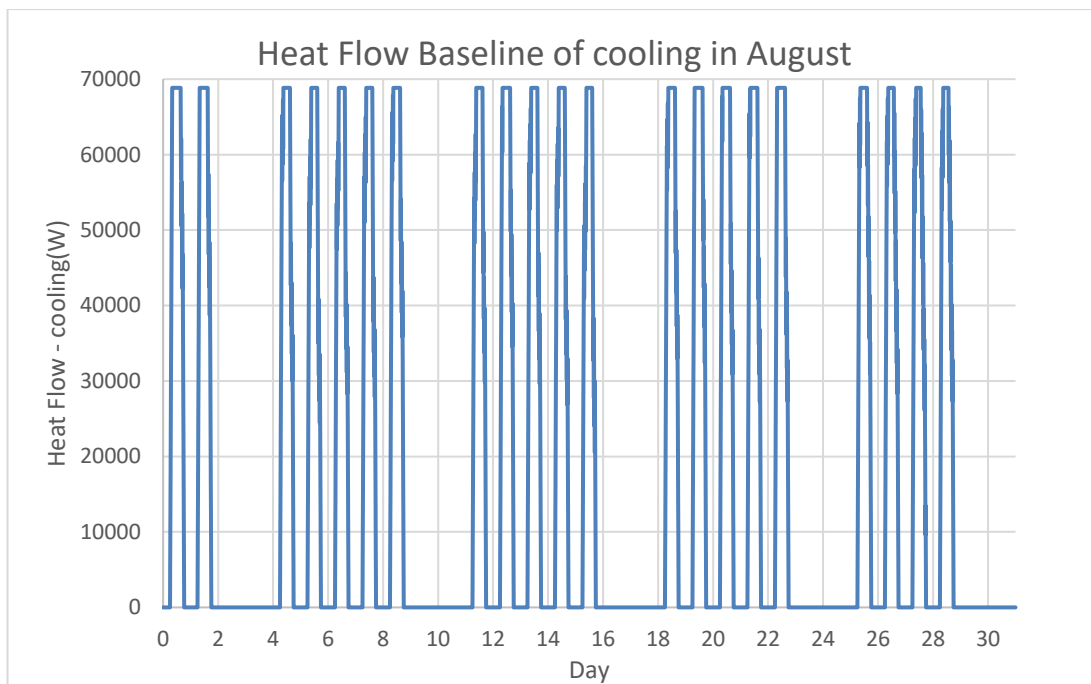

Figure 33: Heat flow baseline of cooling in August.

The heat flow counter calculates the energy for cooling seen in Fig. (32). The outcome is about 7890 kWh/Month, where Fig. (33) shows the temporary heat flow for cooling in each time step. It can be seen that all of the period of August the maximum heat flow occurs. This is due to high ambient temperature and high heat gains inside the building, adding to that; in this baseline scenario it seems that the building needs more cooling input power to maintain acceptable room temperature despite the high gains inside the building on the internal heating.

The heating and cooling loads are a function of room temperature at which the air conditioning starts to cool out the room. In this case, the lower limit is 24 °C and the higher limit is 26 °C. In Fig. (38), the influence of different



temperature limits can be seen. The room temperature is caused by the given boundary conditions and parameters of the models.

The energy for heating is shown in Fig. (34) for February, this month was chosen despite January colder than it because of the minimum working days in January, when the AC would be off. The temporary heat flow is shown in Fig. (35), it can be seen that the maximum cooling heat flow is about 67288.1, and it occurs on fifth of February.

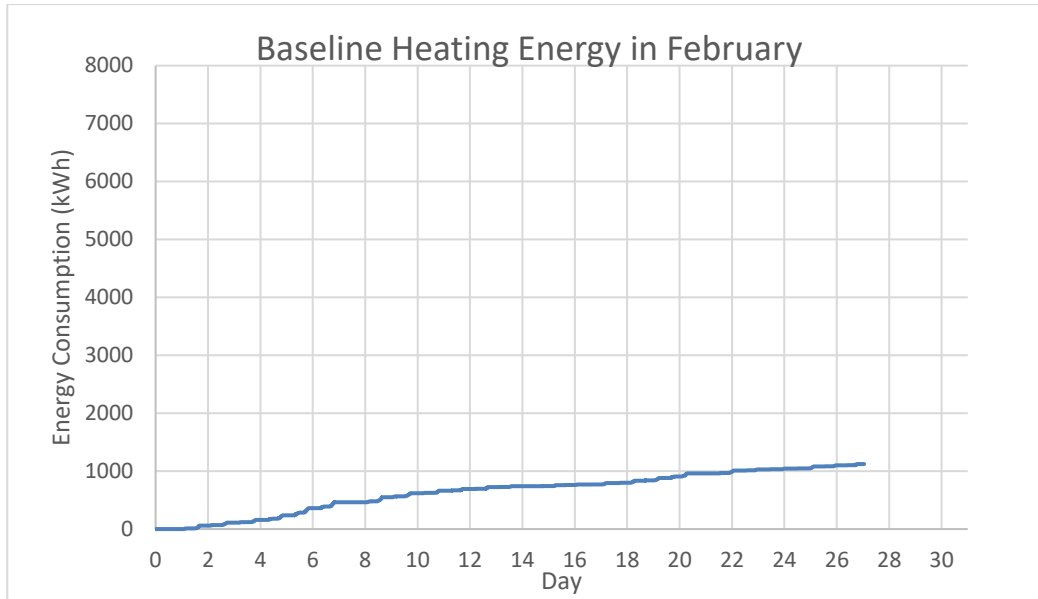

Figure 34: Baseline heating energy in February.

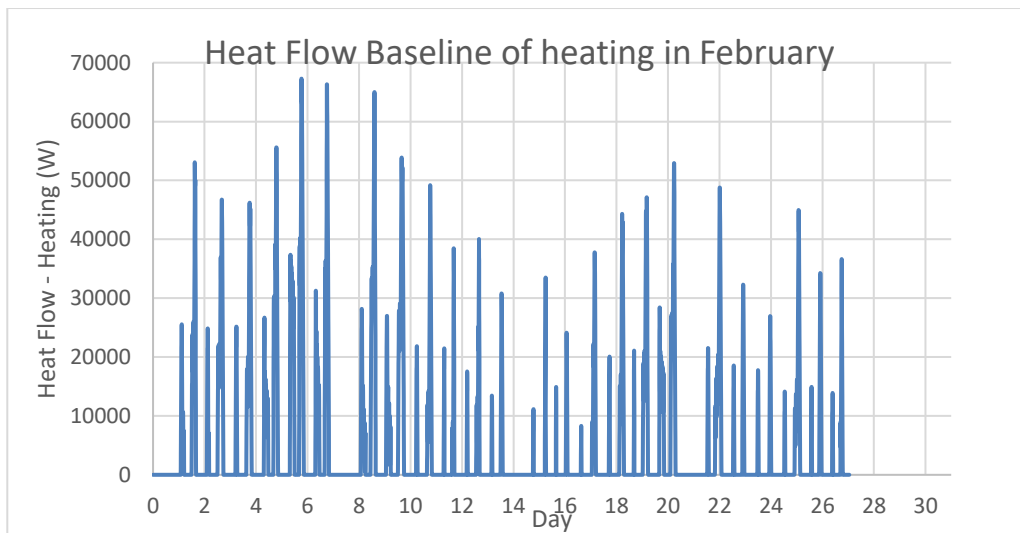

Figure 35: Heat flow baseline of heating in February.

After the two single simulations of February and August, which intended to represent the thermal loads of the coldest and hottest months, a total year was simulated. The results can be found in Fig. (36-37).

Fig. (36) shows the yearly development of the heating, cooling and total energy. The yearly heating load is 6295 kWh/y and for cooling 46276 kWh/y. Therefore, about six-seventh of thermal energy is needed for cooling regarding the chosen boundary conditions.

Table 21 represent the percentages of the heating and cooling through one year.

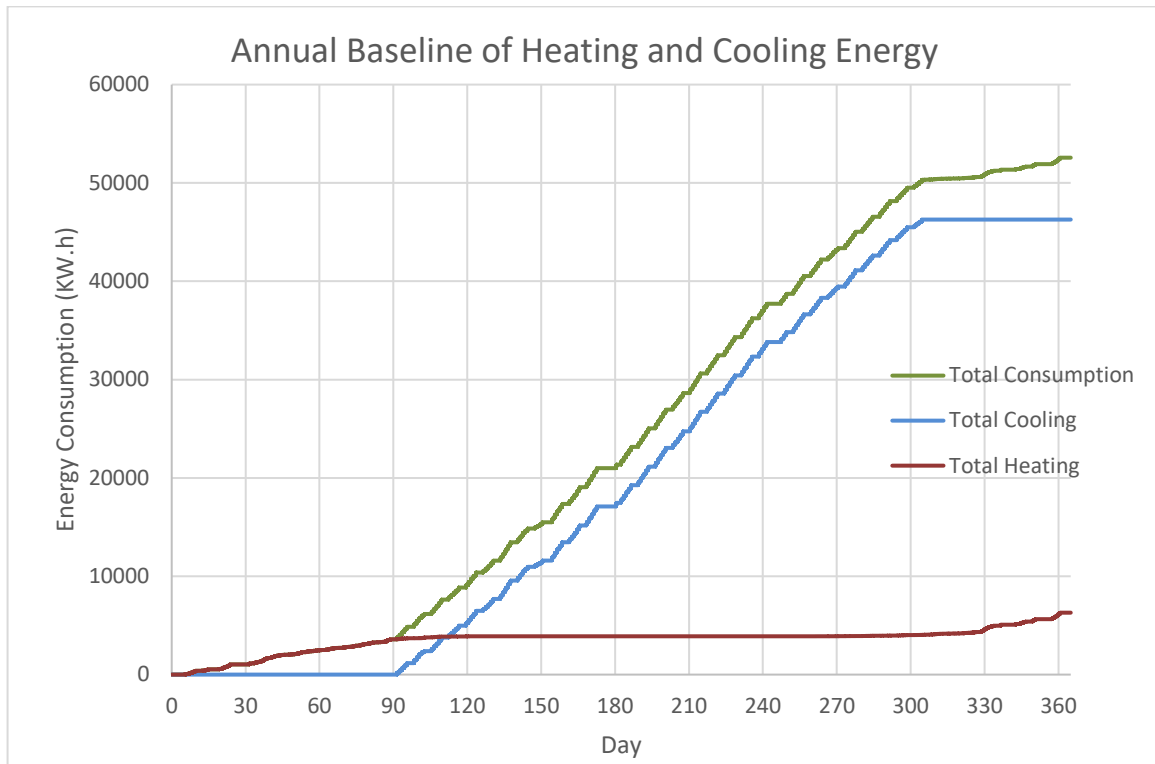

Figure 36: Annual baseline energy, heating, cooling and total.

Table 21: Heating, cooling and total loads of ELREHA facility.

	Yearly Load [kWh/y]	Percentage [%]
Heating	6295	12%
Cooling	46276	88%
Total	52571	100%

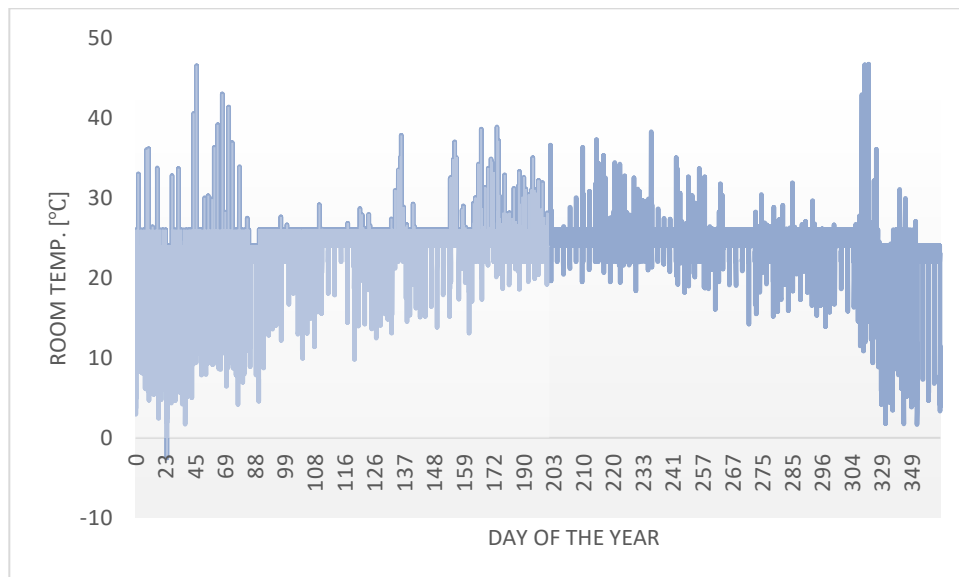
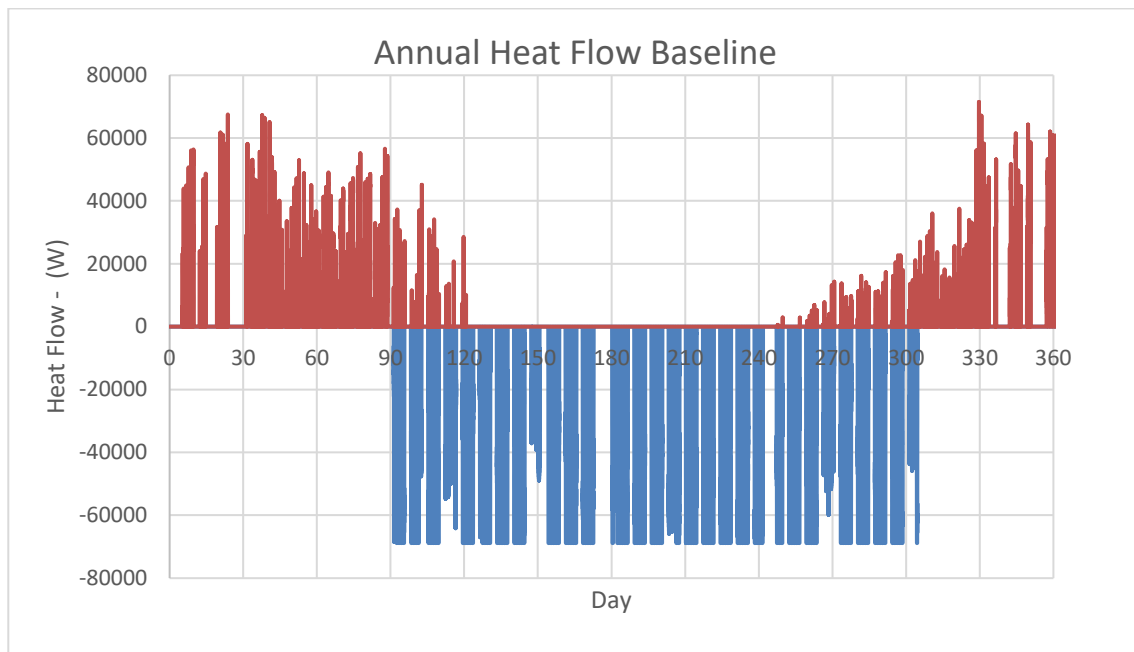

Figure 37: Room temperature of the model.

The simulated room temperature can be seen in Fig. 37, it can be seen that in the winter months, the room temperature can be lower than the lower limit, and in the summer months higher than the upper limit, this is because the air conditioning does not run all the time. It is turned off when no people are in the facility, it only runs in the working days in specific working hours.



**Figure 38:** Annual baseline heat flow.

Fig. (38) gives an overview about heating and cooling periods. Heating is necessary starting from November until the end of March. On the other hand, cooling starts in March and lasts until November. It can be seen that there is not a clear separation between these periods, in these two months there is a cross over, so heating and cooling may be required depending on the ambient temperature.

## 9.2. Sensitivity Analysis

This section presents the influence on the results by changing a selection of parameters, some of them will affect the thermal model while others will affect both models (Thermal and Electrical)

### 9.2.1. Heating and Cooling Limits $\Delta T = \pm 2 K$

The lower and upper boundary conditions of the AC-model are changed, Fig. (39) shows the influence on the yearly heating and cooling load by moving these limits, this parameter will affect the thermal model directly. It can be noticed that in case of heating the range of the yearly load moves between -33% and about 43%, when the temperature varies  $\Delta T = \pm 2 K$ , while the influence on the yearly cooling load is slightly smaller and varies in the sector of -9% and 8%. Therefore, as the impact of this parameter relatively high, it is important to highlight the influence of the chosen limits.

### 9.2.2. Air Exchange $\pm 30\%$

The choice of the ventilation rate could be difficult especially in winter season, as it depends on the kind of heat generator. Fig. (40) shows the influence of ventilation rate on the yearly load.

It can be noticed from the graph that if the ventilation rate increases; the load will increase as well, and vice versa. The yearly total load lies between -6% and 7%, the influence of this is relatively low compared to the variation in limit conditions, but this may be because of the large area of the zone.

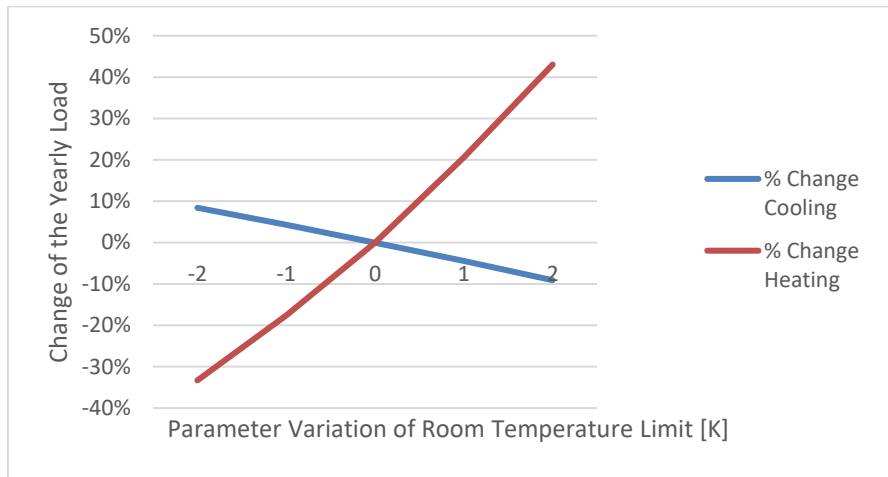

**Figure 39:** Sensitivity analysis variation of the room temperature limits.

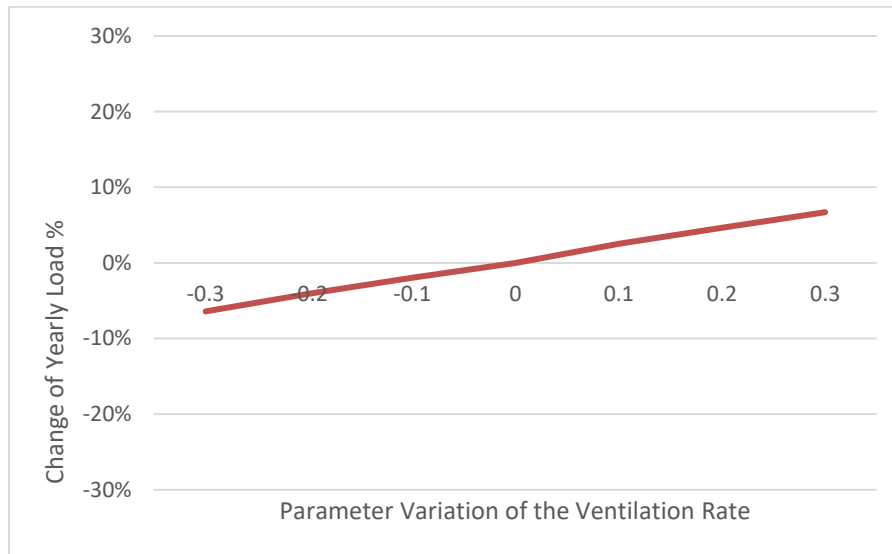

**Figure 40:** Sensitivity analysis variation of ventilation rate

**9.2.3. Person’s Heat ±20%**

This section is about the influence of number of people inside the building, the average number of people in ELREHA facility is about 52. This number was varied ±20%, it can be seen that the influence of this parameter with the load is crosswise. If the number of people increases then the heating load decreases, where for the cooling load it increases with increasing people.

The yearly load heat change, it goes from 7% down to -7%, and in the case of yearly cooling load goes from -2% up to 3% when the number of people increases. As the percentage of the cooling (88%) is higher than the heating, the cooling load influences the curve of the total load more. As seen in Fig. (41), the total load varies between -2% and 2%.

**9.2.4. Windows Area ±15%**

The window areas are defined as part of the external wall; there are two types of heat flow; heat transfer and solar radiation. Fig. (42) shows the influence of the window area, it indicates that almost zero change, but for 15% increase in windows areas the heat load will increase by 1%, and the opposite will happen once the windows are decreased by 15%.

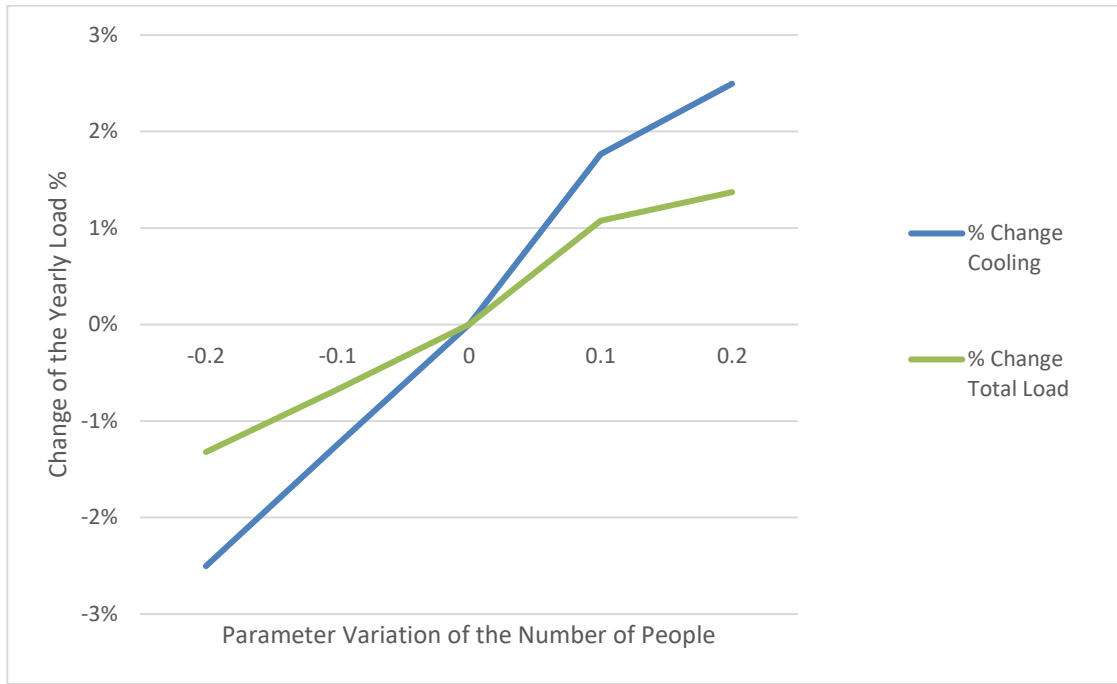

**Figure 41:** Sensitivity analysis variation of number of people.

It should be noted that the area of the facility is large (51x32) m<sup>2</sup>, and the windows are small comparing to the total area. The solar radiation is included in this parameter.

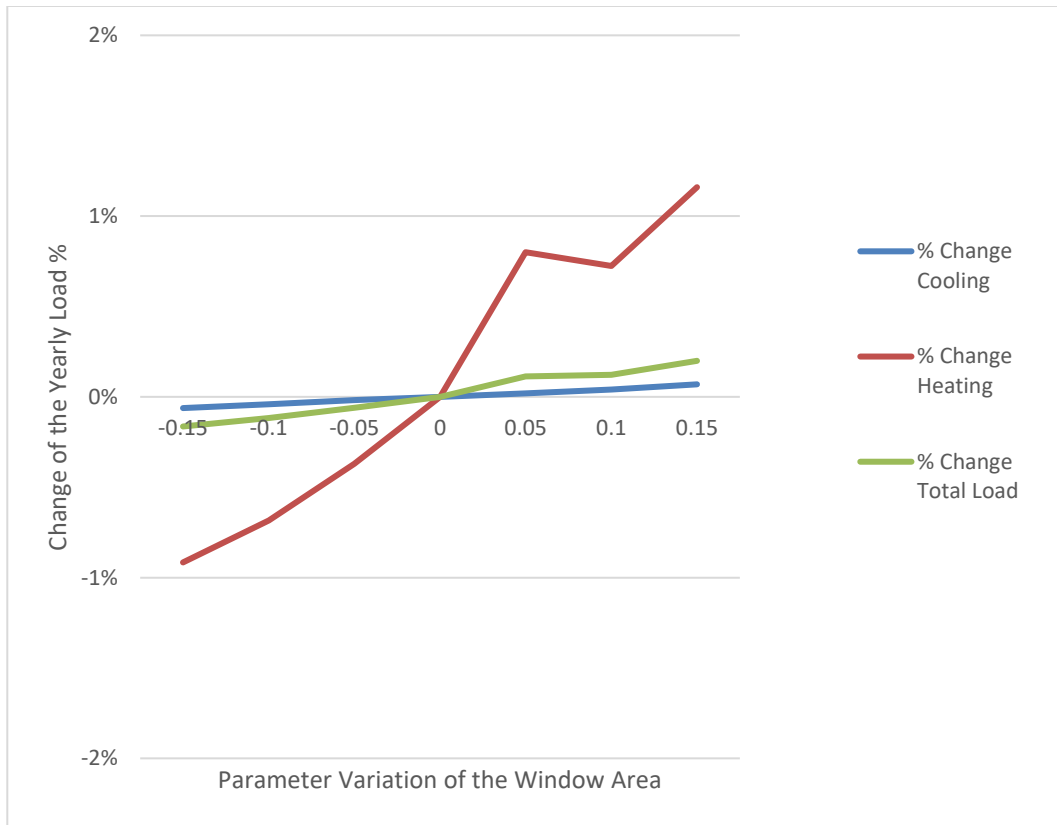

**Figure 42:** Sensitivity analysis variation of window area.

### 9.3. Energy-Savings

#### 9.3.1. Replacing Single Glazed Windows to Double Glaze

This section is about replacing the single-glazing windows, which are commonly used in Jordan, the relative energy-saving is shown in Table 22, U-value of the double-glazing= 3.2.

**Table 22: Double glaze simulation results.**

	Load [kWh]	Change of the Yearly Load	Energy-Saving [kWh]
Heating Load	10698.75	0.5%	-48.69
Cooling Load	78520.28	-0.2%	168.06
Total Load	89218.89	-0.1%	119.5

It could be noticed that the change of yearly load is not high, nevertheless for the heating load it increased from baseline by 0.5% and decreased 0.1% for the total load.

#### 9.3.2. Add Shading to Windows (Single Glaze)

This section is about adding shading to the windows, the relative energy-saving is shown in Table 23.

**Table 23: Shading to windows simulation results.**

	Load [kWh]	Change of the Yearly Load	Energy-Saving [kWh]
Heating Load	7614.67	-28.5%	3035.39
Cooling Load	77548.33	-1.4%	1140
Total Load	85163.06	-4.7%	4175.39

This choice is for the summer season, as in winter the target is to collect as much energy as possible to heat up the space. Thus, the yearly total load reduction is 4.7%.

#### 9.3.3. Adding Roof Insulation

This section is about adding insulation to the roof, Rockwool was added with thickness of 0.1 m in the simulation, U-value of the roof will become 0.331W/m<sup>2</sup>.K. The results are shown in Table 24.

It is seen that the yearly heating load decreases about 4.9% and in the case of cooling about 0.2%, this causes a total reduction of 0.8%.

**Table 24: Roof insulation simulation results.**

	Load [kWh]	Change of the Yearly Load	Energy-Saving [kWh]
Heating Load	10132.94	-4.9%	517.11
Cooling Load	78517.78	-0.2%	170.56
Total Load	88650.56	-0.8%	687.83

#### 9.3.4. Replace Fluorescent Lights with LED Lights

This energy-saving option will affect the thermal and electrical models significantly as seen in Tables 25 and 26. The total percentage of energy-saving will be 4.4% for the thermal load, and 4.8% for the electrical load.

**Table 25: Replace fluorescent lights with LED simulation results.**

	Load [kWh]	Change of the Yearly Load	Energy-Saving [kWh]
Heating Load	12178.33	14.3%	-1528.28
Cooling Load	75008.89	-4.7%	3679.44
Total Load	87187.22	-2.4%	2151.17

**Table 26: Replace fluorescent lights with LED simulation results.**

Electricity Consumption [kWh]	Energy-Saving [kWh]	Percentage of Energy-Saving [%]
219940.69	11177.86	4.8

### 9.3.5. Energy Saving Options 1 & 2 Combined: Replacing Single Glaze Windows to Double Glaze and Add Shading to Windows

The energy-saving is 4.9% for the thermal load, as seen in Table 27.

**Table 27: Shading with double glaze windows simulation results.**

	Load [kWh]	Change of the Yearly Load	Energy-Saving [kWh]
Heating Load	7672.72	-28.0%	2977.33
Cooling Load	77266.11	-1.8%	1422.22
Total Load	84938.89	-4.9%	4399.5

### 9.3.6. Energy Saving 1 & 2 & 3 & 4 (All Combined)

If all energy options were combined; double glaze windows with added shading and roof insulation plus replacing the fluorescent lights with LED ones, then the result would be a reduction of almost 9% of the yearly total thermal load, as seen in Tables 28 and 29.

**Table 28: All energy-saving suggestions combined simulation results.**

	Load [kWh]	Change of the Yearly Load	Energy-Saving [kWh]
Heating Load	8402.39	-21.1%	-2247.67
Cooling Load	72950.28	-7.3%	-5738.06
Total Load	81385.28	-8.9%	-7953.11

**Table 29: All energy-saving suggestions combined simulation results.**

Electricity Consumption [kWh]	Energy-Saving [kWh]	Percentage of Energy-Saving [%]
219940.69	11177.86	4.8

#### 9.3.6.1. Summary of Energy-Saving Options

The previous sections gave an overview about different energy-saving options. Table 30 summarizes the results of both Thermal and Electrical loads, the savings is shown in Fig. (43).

**Table 30: Summary of yearly energy-saving results.**

Energy-Saving Option	Energy-Saving [kWh/y]	Electricity Consumption Saving [kWh/y]	Percentage of Electricity Consumption Saving [%]
Roof insulation	687.83	574.16	0.2%
Double glazing	4175.33	2511.66	1.1%
Shading with single glazing	119.5	258.42	0.1%
Replace flu with LED	2151.17	11177.86	4.8%
Double glaze with shading	4399.5	2636.20	1.1%
Roof insulation + double glazing + Shading + replacing flu with LED	7953.11	11383.32	4.9%

In Table 31 the percentages of these options are clarified, it shows that the remaining Electrical consumption yearly load is 216730.33 kWh, with 6.2% of the original load saved by these three options clarified in Table 31 with the compensation of each one to the energy-saving. It can be noted that replacing the fluorescent lights with LED compensates for the highest saving percentage among the three, which is 78%. The thermal saved load is 8.1% with the three options combined.

**Table 31: Yearly energy by chosen options combined and their percentages.**

Energy-Saving Option	Energy Saving [kWh/y]	Percentage of Energy-Saving [%]	Electricity Consumption Saving [kWh/y]	Percentage of Electricity Consumption Saving [%]
Roof insulation	687.83	9.5%	574.16	4.0%
Double glaze with shading	4399.5	60.8%	2636.2	18.3%
Replace flu. with LED	2151.17	29.7%	11177.86	77.7%
Total	7238.5	100%	14388.22	100%

The highest influence on the thermal load reduction is using the double glaze with shading with 61%, then replacing the fluorescent with LED because of the lower heat gains of LED with 30%, and finally, the roof insulation is the smallest influence with 9.5%.

For the total consumption; the highest percentage is for replacing the fluorescent with LED with 78%, then double glaze with shading, and finally the lowest is for the roof insulation.

## 10. Conclusions and Recommendations

### 10.1. Conclusions

The main objective of this study was to develop an assessment decision-making tool through dynamic simulation software in a calendar year. To be used in the energy audit process for manufacturing buildings in Jordan, to save time, and cost and allow the interested parties of the building to observe a preliminary assessment on opportunities to implement energy-related decisions that would achieve the targets of the audit.

Start with an overview of energy auditing and its procedures, giving a literature review showing types and levels of energy audition then discuss a case study of ELREHA Manufacturing Facility discussing its structural conditions and operational duties, then start modelling our case study considering a thermodynamic behavior of manufacturing building in the first step. This model will consider heating and cooling load variation due to all parameters that could change in time making an annual simulation finding electrical consumption through time.



Energy collection was the first step in the study methodology to build a good understanding of facility condition and duties to build a reliable model, some assumptions were assumed making the model reusable for manufacturing building in Jordan:

- Have one floor
- Have one unheated area at maximum
- Have at maximum one side external unheated area exposed side
- Dealing with the Attic ceiling as an unheated area

The final model was introduced as a detailed energy auditing model that could be used in many manufacturing facilities, which gives a great help in figuring opportunities that could reduce energy consumption.

Verification and validation of the model were made. Aimed to build a model that could give accurate data enhancing energy auditing.

The yearly heating load baseline was 6295 kWh/y (12%) and for cooling 46276 kWh/y (88%). Therefore, about six-seventh of thermal energy is needed for cooling regarding the chosen boundary conditions.

The graphic editor Dymola and the programming language Modelica are powerful tools that allow the calculating of any physically based problems. The advantage of the simulations is the ability to calculate the desired values without expensive experiments; they can be used to calculate energy efficiency methods for new constructions before they are built. In simulation projects; the more conditions are given the less assumptions; the closer is the simulation results to reality.

The influence of the chosen parameters was calculated by sensitivity analysis for four different variables. The first was about the limit temperatures of the AC, the influence was very high compared to the other parameters with at least 20% of load change due to a variation of  $\Delta T=1K$ . The influence of the window area is relatively low, about 1% with a variation of 15%. The influence of this parameter on the load is crosswise. If the number of people increases then the heating load decreases, and the cooling load increases with increasing number of people.

The energy-saving opportunities were the highest with 4.8% when changing the fluorescent lights to LED lights. On the other hand, an energy opportunity like changing the window from single to double glaze with shading; will not make a high saving opportunity concerning the electrical consumption but provide a more comfortable working environment and energy-saving in the thermal loads.

The remaining electrical consumption yearly load after applying three energy-saving options together was 216730.33 kWh, with 6.2% of the original load can be saved by these three options, it can be noted that replacing the fluorescent lights with LED compensating for the highest saving percentage among the three, where it is 78%. The thermal saved load is 8.1% with the three options combined.

## 10.2. Recommendations

Based on the experiences of these simulations the following recommendations for continuative projects could be given:

- Aiming to generalize model usage consideration of more variation in machining and operation process in such building and expansion structural variation considering building age and deities could be made
- Creating economic and environmental detailed assessments

## Conflicts of Interest

The authors declare that there are no conflicts of interest regarding the publication of this paper.

## Funding

None.

## Acknowledgments

The authors thank Technical University of Hamburg-Institute for Environmental Technology, for the technical assistance.

## References

- [1] Al-omary M, Kaltschmitt M, Becker C. Electricity system in Jordan: Status & prospects. *Renew Sustain Energy Rev.* 2018; 2398-409. <https://doi.org/10.1016/j.rser.2017.06.046>
- [2] Tawalbeh M. Energy Efficiency; Current Trends and Future Perspectives in Jordan. Royal Scientific Society; International workshop, Athens: 22-23/2/2016. Available from: [http://www.cres.gr/kape/publications/pdf/mare\\_2016/12\\_Tawalbeh.pdf](http://www.cres.gr/kape/publications/pdf/mare_2016/12_Tawalbeh.pdf)
- [3] Hassouneh K, Al-Salaymeh A, Qoussous J. Energy audit, an approach to apply the concept of green building for a building in Jordan. *Sustain Cities Soc.* 2015; 14: 456-62. <https://doi.org/10.1016/J.SCS.2014.08.010>
- [4] Hasanbeigi A, Price L. Industrial energy audit guidebook: guidelines for conducting an energy audit in industrial facilities. Lawrence Berkeley National Laboratory; 2010, LBNL Report #: LBNL-3991E. Available from: <https://escholarship.org/uc/item/4rw140wk>
- [5] Coakley D, Raftery P, Keane M. A review of methods to match building energy simulation models to measured data. *Renew Sustain Energy Rev.* 2014; 37: 123-41. <https://doi.org/10.1016/j.rser.2014.05.007>
- [6] Bhatt MS. Energy audit case studies I—steam systems. *Appl Therm Eng.* 2000; 20(3): 285-96.
- [7] Albert T, Terry N, William WJ. Handbook of energy audits. 9th ed. Distributed by Taylor & Francis Ltd., FL 33487, USA: 2012.
- [8] Saltelli A, Ratto M, Andres T, Campolongo F, Cariboni J, Gatelli D, *et al.* Global sensitivity analysis: the primer. John Wiley & Sons Ltd.; England: 2007.
- [9] Crawley DB, Hand JW, Kummert M, Griffith BT. Contrasting the capabilities of building energy performance simulation programs. *Build Environ.* 2008; 43(4): 661-73. <https://doi.org/10.1016/j.buildenv.2006.10.027>
- [10] Lucentini M, Rottenberg F, Di Palma D. A model for the evaluation of energy indicators in end users audit for hospital sector. ASME 2011 International Mechanical Engineering Congress and Exposition, Denver, Colorado, USA: November 11-17, 2011, Paper No: IMECE2011-63434, pp. 305-11. <https://doi.org/10.1115/IMECE2011-63434>
- [11] Keirstead J, Jennings M, Sivakumar A. A review of urban energy system models: Approaches, challenges and opportunities. *Renew Sustain Energy Rev.* 2012; 16(6): 3847-66. <https://doi.org/10.1016/j.rser.2012.02.047>
- [12] Obara H, Azar M, Curci F. Method and tools for assessment of energy performance of buildings- case study. Sustainable Building Conference 2016, Turin: February 2016.
- [13] Wang S, Yan C, Xiao F. Quantitative energy performance assessment methods for existing buildings. *Energy Build.* 2012; 55: 873-88. <https://doi.org/10.1016/j.enbuild.2012.08.037>
- [14] Dongellini M, Marinosci C, Morini GL. Energy Audit of an Industrial Site: A Case Study. *Energy Procedia.* 2014; 45: 424-33. <https://doi.org/10.1016/j.egypro.2014.01.046>
- [15] Traoré I, Valentin G, Riffonneau Y, l'henoret B, drouet E. Development of a generic and scalable modelica based model of a typical french railway station. Application to forecast, scheduling and energy consumption management. Proceedings of Building Simulation 2013: 13th Conference of IBPSA, Chambéry, France: August 26-28, 2013, pp. 2139. <https://doi.org/10.26868/25222708.2013.1229>
- [16] Wetter M. A view on future building system modeling and simulation. In Hensen JLM, Lamberts R, Eds., Building performance simulation for design and operation. UK: Routledge; 2011, pp. 631-56.
- [17] Ruiz G, Bandera C. Validation of calibrated energy models: common errors. *Energies* 2017; 10(10): 1587. <https://doi.org/10.3390/en10101587>
- [18] Akash BA, Mohsen MS. Current situation of energy consumption in the Jordanian industry. *Energy Convers Manag.* 2003; 44(9): 1501-10. [https://doi.org/10.1016/S0196-8904\(02\)00146-2](https://doi.org/10.1016/S0196-8904(02)00146-2)
- [19] Kablan M. Energy conservation projects implementation at Jordan's industrial sector: a total quality management approach. *Energy.* 2003; 28(15): 1533-43. [10.1016/S0360-5442\(03\)00129-4](https://doi.org/10.1016/S0360-5442(03)00129-4)
- [20] Al-Ghandoor A, Al-Hinti I. Prospects of energy savings in the Jordanian plastic industry. *Jordan J Mech Ind Eng.* 2007; 1(2): 93-98.
- [21] Al-Widyan M, Soliman I, Alajlouni A, Al Zu'bi O, Jaradat A. Energy performance assessment of a non-domestic service building in Jordan. *Jordan J Mech Ind Eng.* 2018; 12(2): 69-75.
- [22] Sharma P, Salkuti SR, Kim SC. Energy audit: types, scope, methodology and report structure. *Indones J Electr Eng Comput Sci.* 2021; 22(1): 45-52. <http://doi.org/10.11591/ijeecs.v22.i1.pp45-52>

- [23] Alrwashdeh SS. Energy sources assessment in Jordan. *Results Eng.* 2022; 13: 100329. <https://doi.org/10.1016/j.rineng.2021.100329>
- [24] Kuntuarova S, Lickleder T, Huynh T, Zinsmeister D, Hamacher T, Perić V. Design and simulation of district heating networks: a review of modeling approaches and tools. *Energy.* 2024; 305: 132189. <https://doi.org/10.1016/j.energy.2024.132189>
- [25] Cucca G, Ianakiev A. Assessment and optimisation of energy consumption in building communities using an innovative co-simulation tool. *J Build Eng.* 2020; 32: 101681. <https://doi.org/10.1016/j.jobe.2020.101681>
- [26] Alasmar R, Schwartz Y, Burman E. Developing a housing stock model for evaluating energy Performance: The case of Jordan. *Energy Build.* 2024; 308: 114010. <https://doi.org/10.1016/j.enbuild.2024.114010>
- [27] Sandri S, Hussein H, Alshyab N. Sustainability of the energy sector in Jordan: Challenges and opportunities. *sustainability.* 2020; 12(24): 10465. <https://doi.org/10.3390/su122410465>
- [28] Nagy Z, Henze G, Dey S, Arroyo J, Helsen L, Zhang X, *et al.* Ten questions concerning reinforcement learning for building energy management. *Build Environ.* 2023; 241: 110435. <https://doi.org/10.1016/j.buildenv.2023.110435>
- [29] Khan AA, Minai AF. A strategic review: the role of commercially available tools for planning, modelling, optimization, and performance measurement of photovoltaic systems. *Energy Harvest Syst.* 2024; 11(1): 20220157. <https://doi.org/10.1515/ehs-2022-0157>
- [30] Muhić S, Dimitrije Manić, Ante Čikić, Komatina M. Influence of building thermal envelope modeling parameters on results of building energy simulation. *J Build Eng.* 2024; 87: 109011. <https://doi.org/10.1016/j.jobe.2024.109011>
- [31] Joshi A, Khandelwal N, Suryavanshi Y, Broota S, Kurulekar M, Dhaneshwar P. Energy conservation: Virtual energy audit of an industrial plant. *Mater Today.* 2023; 72: 1882-9. <https://doi.org/10.1016/j.matpr.2022.10.055>
- [32] Zipplies J, Orozaliev J, Jordan U, Vajen K. Heat consumer model for robust and fast simulations of district heating networks using modelica. *Electronics.* 2024; 13(7): 1201. <https://doi.org/10.3390/electronics13071201>
- [33] Al Momani D, Al Turk Y, Abuashour MI, Khalid HM, Muyeen SM, Sweidan TO, *et al.* Energy saving potential analysis applying factory scale energy audit – A case study of food production. *Heliyon.* 2023; 9(3): e14216. <https://doi.org/10.1016/j.heliyon.2023.e14216>
- [34] Qiu K, Yang J, Gao Z, Xu F. A review of Modelica language in building and energy: Development, applications, and future prospect. *Energy Build.* 2024; 113998. <https://doi.org/10.1016/j.enbuild.2024.113998>
- [35] Hinkelman K, Wang J, Zuo W, Gautier A, Wetter M, Fan C, *et al.* Modelica-based modeling and simulation of district cooling systems: A case study. *Appl Energy.* 2022; 311: 118654. <https://doi.org/10.1016/j.apenergy.2022.118654>
- [36] Akpahou R, Mensah LD, Quansah DA, Kemausuor F. Energy planning and modeling tools for sustainable development: A systematic literature review. *Energy Rep.* 2024; 11: 830-45. <https://doi.org/10.1016/j.egy.2023.11.043>
- [37] Martin O. Modelica Association (Hrsg.): Modelica Overview. Available from: <https://www.modelica.org/>. Version: 2009
- [38] Mathias MR. Object oriented modeling thermal building behavior. (Dissertation) University of Kaiserslautern; 2002.
- [39] Clemens H. Dynamic simulation of the heating and cooling loads of Jordanian households with Dymola. (Master Thesis) Hamburg: Technische Universität Hamburg; 2017.
- [40] Alsaad MA, Hammad MA. Heating and air conditioning for residential buildings. 5th ed. Library Catalog (Koha). Amman: Alsaad; 2011.
- [41] Al-Sheraidh MY. Low energy and energy rating for apartment buildings in Jordan. (Master Thesis) Amman: University of Jordan; 2015.
- [42] ASHRAE Fundamentals (2013), ASHRAE, 1791 Tullie Circle, N.E., Atlanta, GA 30329. Available from: [www.Ashrae.org](http://www.Ashrae.org)
- [43] Renewables.ninja. Available from: <https://www.renewables.ninja>
- [44] Schmitz G. Thermal Engineering: Script for the lecture use. TUHH, Hamburg, Germany, 2012.

# Appendixes

## A. Figures

### A.1: Connection diagram of Zone A

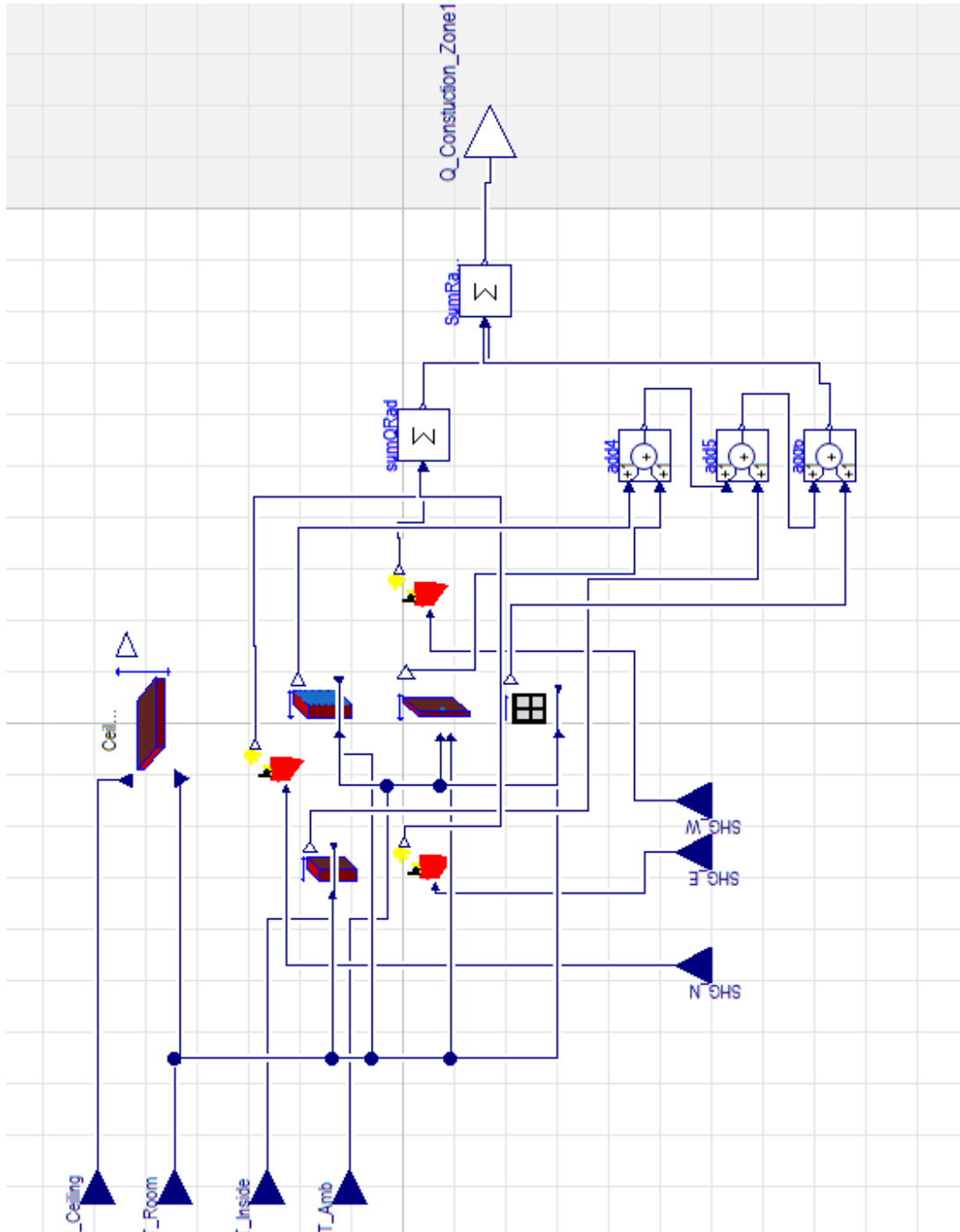

**Figure A. 1:** Connection diagram of Zone A.

**A.2: Connection diagram of Ceiling-Roof**

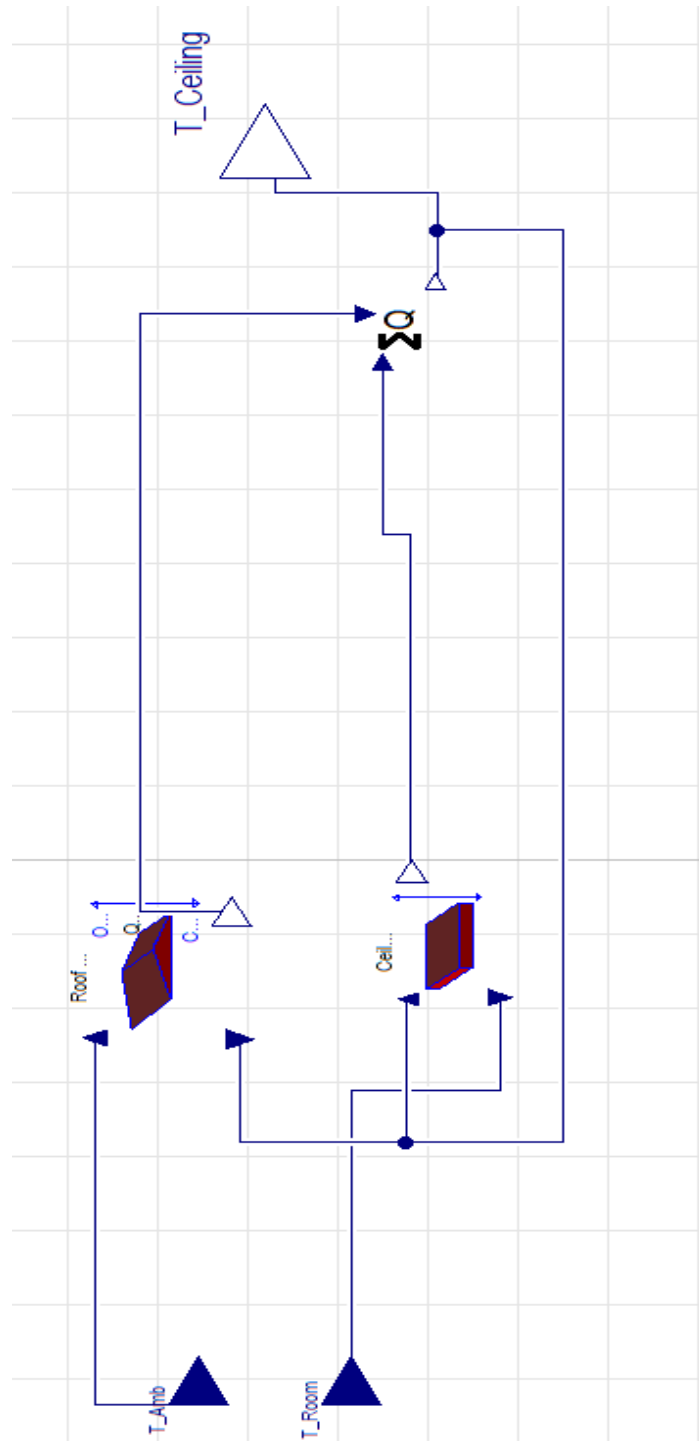

**Figure A. 2:** Connection diagram of Ceiling- Roof.