

Sustainable Food Production in Greenhouses and Its Relations to the Environment

Abdeen Mustafa Omer*

Energy Research Institute (ERI), School of Chemical and Process Engineering, University of Leeds, UK

Abstract: A greenhouse is essentially an enclosed structure, which traps the short wavelength solar radiation and stores the long wavelength thermal radiation to create a favourable microclimate for higher productivity. The sun's radiation incident on the greenhouse has two parts: direct radiation and an associated diffuse sky radiation. The diffuse part is not focused by the lenses and goes right through Fresnel lenses onto the surface of the absorbers. This energy is absorbed and transformed into heat, which is then transported *via* the liquid medium in copper pipes to the water (heat) storage tanks or, if used, open fish tanks. In this way, an optimal temperature for both plant cultivation and fish production can be maintained. Stable plant growth conditions are light, temperature and air humidity. Light for the photosynthesis of plants comes from the diffuse radiation, which is without substantial fluctuations and variation throughout most of the day. The air temperature inside the greenhouse is one of the factors that have an influence on the precocity of production. The selective collector acts in a more perceptible way on extreme air temperatures inside the greenhouse. Hence, the system makes it possible to avoid the excessive deviation of the temperature inside the greenhouse and provides a favourable microclimate for the precocity of the culture. Sediment and some associated water from the sediment traps are used as organic fertiliser for the plant cultivation. The present trend in greenhouse cultivation is to extend the crop production season in order to maximise use of the equipment and increase annual productivity and profitability. However, in many Mediterranean greenhouses, such practices are limited because the improper cooling methods (mainly natural or forced ventilation) used do not provide the desired micro-climatic condition during the summer of a composite climate. Also, some of these greenhouses have been built where the meteorological conditions require some heating during the winter, particularly at night. The worst scenario is during the winter months when relatively large difference in temperature between day and night occurs. However, overheating of the greenhouse during the day is common, even in winter, requiring ventilation of the structure. Hence, several techniques have been proposed for the storage of the solar energy received by the greenhouse during the day and its use to heat the structure at night. Reviews of such techniques are presented in this paper. Air or water can be used for heat transport. The circulating water is heated during the day *via* two processes. The water absorbs part of the infrared radiation of the solar spectrum. Since the water is transparent in the visible region, they do not compete with the plants that need it. Alternatively, the water exchanges heat with the greenhouse air through the walls. At night, if the greenhouse temperature goes down below a specified value, the water begins to circulate acting as heat transfer surfaces heating the air in the greenhouse. This communication describes various designs of low energy greenhouses. It also, outlines the effect of dense urban building nature on energy consumption, and its contribution to climate change. The objectives are to produce vegetables in greenhouse environment. Measures, which would help to save energy in greenhouses, are also presented. It also enabled the minimisation of temperature variation and, hence avoided the hazard of any sudden climatic change inside the greenhouse.

Keywords: Greenhouse environment, energy efficient comfort, ventilation, humidity, sustainable environmental impact.

1. INTRODUCTION

Globally, buildings are responsible for approximately 40% of the total world annual energy consumption [1]. Most of this energy is for the provision of lighting, heating, cooling, and air conditioning. Increasing awareness of the environmental impact of CO₂ and NO_x emissions and CFCs triggered a renewed interest in environmentally friendly cooling, and heating technologies. Under the 1997 Montreal Protocol, governments agreed to phase out chemicals used as refrigerants that have the potential to destroy stratospheric ozone [1]. It was therefore considered desirable to reduce energy consumption and decrease the rate of depletion of world energy reserves and pollution of the environment.

One way of reducing building energy consumption is to design building, which is more economical in their use of energy for heating, lighting, cooling, ventilation and hot water supply. Passive measures, particularly natural or hybrid ventilation rather than air-conditioning, can dramatically reduce primary energy consumption [2]. However, exploitation of renewable energy in buildings and agricultural greenhouses can, also, significantly contribute towards reducing dependency on fossil fuels. Therefore, promoting innovative renewable applications and reinforcing the renewable energy market will contribute to preservation of the ecosystem by reducing emissions at local and global levels. This will also contribute to the amelioration of environmental conditions by replacing conventional fuels with renewable energies that produce no air pollution or greenhouse gases.

The provision of good indoor environmental quality while achieving energy and cost efficient operation of

*Address correspondence to this author at the Energy Research Institute (ERI), School of Chemical and Process Engineering, University of Leeds, UK; Tel: 00441159421480; Fax: 00441159421480; E-mail: abdeenomer2@yahoo.co.uk

the heating, ventilating and air-conditioning (HVAC) plants in buildings represents a multi variant problem. The comfort of building occupants is dependent on many environmental parameters including air speed, temperature, relative humidity and quality in addition to lighting and noise. The overall objective is to provide a high level of building performance (BP), which can be defined as indoor environmental quality (IEQ), energy efficiency (EE) and cost efficiency (CE).

- Indoor environmental quality is the perceived condition of comfort that building occupants experience due to the physical and psychological conditions to which they are exposed by their surroundings. The main physical parameters affecting IEQ are air speed, temperature, relative humidity and quality [2].
- Energy efficiency is related to the provision of the desired environmental conditions while consuming the minimal quantity of energy [2].
- Cost efficiency is the financial expenditure on energy relative to the level of environmental comfort and productivity that the building occupants attained. The overall cost efficiency can be improved by improving the indoor environmental quality and the energy efficiency of a building [2].

An approach is needed to integrate renewable energies in a way to meet high building performance. However, because renewable energy sources are stochastic and geographically diffuse, their ability to match demand is determined by adoption of one of the following two approaches [2]: the utilisation of a capture area greater than that occupied by the community to be supplied, or the reduction of the community's energy demands to a level commensurate with the locally available renewable resources.

For a northern European climate, which is characterised by an average annual solar irradiance of 150Wm^{-2} , the mean power production from a photovoltaic component of 13% conversion efficiency is approximately 20Wm^{-2} [3]. For an average wind speed of 5ms^{-1} , the power produced by a micro wind turbine will be of a similar order of magnitude, though with a different profile shape [3]. In the UK, for example, a typical office building will have a demand in the order of $300\text{kWhm}^{-2}\text{yr}^{-1}$ [3]. This translates into approximately 50Wm^{-2} of façade, which is twice as much as the available renewable energies [3]. Thus, the aim is to

utilise energy efficiency measures in order to reduce the overall energy consumption and adjust the demand profiles to be met by renewable energies. For instance, this approach can be applied to greenhouses, which use solar energy to provide indoor environmental quality.

The greenhouse effect is one result of the differing properties of heat radiation when it is generated at different temperatures. Objects inside the greenhouse, or any other building, such as plants, re-radiate the heat or absorb it. Because the objects inside the greenhouse are at a lower temperature than the sun, the re-radiated heat is of longer wavelengths, and cannot penetrate the glass. This re-radiated heat is trapped and causes the temperature inside the greenhouse to rise. Note that the atmosphere surrounding the earth, also, behaves as a large greenhouse around the world. Changes to the gases in the atmosphere, such as increased carbon dioxide content from the burning of fossil fuels, can act like a layer of glass and reduce the quantity of heat that the planet earth would otherwise radiate back into space. This particular greenhouse effect, therefore, contributes to global warming. The application of greenhouses for plants growth can be considered one of the measures in the success of solving this problem. Maximising the efficiency gained from a greenhouse can be achieved using various approaches, employing different techniques that could be applied at the design, construction and operational stages. The development of greenhouses could be a solution to farming industry and food security.

The move towards a de-carbonised world, driven partly by climate science and partly by the business opportunities it offers, will need the promotion of environmentally friendly alternatives, if an acceptable stabilisation level of atmospheric carbon dioxide is to be achieved. This requires the harnessing and use of natural resources that produce no air pollution or greenhouse gases and provides comfortable coexistence of human, livestock, and plants. This study reviews the energy-using technologies based on natural resources, which are available to and applicable in the farming industry. Integral concept for buildings with both excellent indoor environment control and sustainable environmental impact are reported in the present communication. Techniques considered are hybrid (controlled natural and mechanical) ventilation including night ventilation, thermo-active building mass systems with free cooling in a cooling tower, and air intake *via* ground heat exchangers.

Special emphasis is put on ventilation concepts utilising ambient energy from air ground and other renewable energy sources, and on the interaction with heating and cooling. It has been observed that for both residential and office buildings, the electricity demand of ventilation systems is related to the overall demand of the building and the potential of photovoltaic systems and advanced co-generation units. The focus of the world's attention on environmental issues in recent years has stimulated response in many countries, which have led to a closer examination of energy conservation strategies for conventional fossil fuels. One way of reducing building energy consumption is to design buildings, which are more economical in their use of energy for heating, lighting, cooling, ventilation and hot water supply [3]. Passive measures, particularly natural or hybrid ventilation rather than air-conditioning, can dramatically reduce primary energy consumption. However, exploitation of renewable energy in buildings and agricultural greenhouses can, also, significantly contribute towards reducing dependency on fossil fuels.

The main advantages of solar greenhouse are summarised as follows [3]:

- In the climatic conditions of Europe, the collector system equipped with linear raster lenses is able to absorb, on average, 12% of the total incoming global solar energy on the collector and convert this energy into heat at a temperature of between 30 to 50°C. The system, therefore, consumes approximately 50% less energy for heating purposes than would a traditional normal greenhouse.
- The system provides suitable, perhaps ideal, conditions for the cultivation of high quality vegetables, and even during periods of maximum solar energy absorption on the collectors, there still remains sufficient light for good vegetable growth under the area of the collectors.
- Due to the almost continuous high humidity levels and to the applied nutrient solution being rich in organic matter and microorganisms, organic matter is hardly mineralising in the soil, hence, does not degrade in patches. On the contrary, organic matter content in the soil increased during cultivation.
- In comparison with a traditional greenhouse, the system does not overheat inside. Therefore, less

ventilation is necessary, which brings the benefits of smaller losses of water. Furthermore, the system saves energy, allows the efficient recycling of water and nutrients, and provides suitable growth conditions with a smaller range of extreme humidity, temperature and light allowing the cultivated plants to face less stress and have a higher quality.

- Due to the relatively low temperature in the greenhouse, additional heating might be required. Therefore, vegetables will adapt to low radiation levels, and low temperatures and, consequently, quality is preserved even during failure of control system.

This study describes various designs of low energy buildings. It also, outline the effect of dense urban building nature on energy consumption, the problems related to inadequate ventilation in buildings, and its contribution to climate change. Measures, which would help to save energy in buildings, are also presented.

2. IDOORS ENVIRONMENT

The heating or cooling of a space to maintain thermal comfort is a highly energy intensive process accounting for as much as 60-70% of total energy use in non-industrial buildings [3]. Of this, approximately 30-50% is lost through ventilation and air infiltration [3]. However, estimation of energy impact of ventilation relies on detailed knowledge about air change rate and the difference in enthalpy between the incoming and outgoing air streams. In practice, this is a difficult exercise to undertake since there is much uncertainty about the value of these parameters [4]. As a result, a suitable datum from which strategic planning for improving the energy efficiency of ventilation can be developed has proved difficult to establish [4]. Efforts to overcome these difficulties are progressing in the following two ways [4]:

- Identifying ventilation rates in a representative cross section of buildings.
- The energy impact of air change in both commercial and domestic buildings.

In addition to conditioning energy, the fan energy needed to provide mechanical ventilation can make a significant further contribution to energy demand. Much depends on the efficiency of design, both in relation to the performance of fans themselves and to the resistance to flow arising from the associated ductwork.

The building sector is an important part of the energy picture. Note that the major function of buildings is to provide an acceptable indoor environment, which allows occupants to carry out various activities. Hence, the purpose behind this energy consumption is to provide a variety of building services, which include weather protection, storage, communications, thermal comfort, facilities of daily living, aesthetics, work environment, etc. However, the three main energy-related building services are space conditioning (for thermal comfort), lighting (for visual comfort), and ventilation (for indoor air quality). Pollution-free environments are a practical impossibility.

Therefore, it is often useful to differentiate between unavoidable pollutants over which little source control is possible, and avoidable pollutants for which control is possible. Unavoidable pollutants are primarily those emitted by metabolism and those arising from the essential activities of occupants. 'Whole building' ventilation usually provides an effective measure to deal with the unavoidable emissions, whereas 'source control' is the preferred, and sometimes only practical, method to address avoidable pollutant sources [5]. Hence, achieving optimum indoor air quality relies on an integrated approach to the removal and control of pollutants using engineering judgment based on source control, filtration, and ventilation. Regardless of the kind of building involved, good indoor air quality requires attention to both source control and ventilation. While there are sources common to many kinds of buildings, buildings focusing on renewable energy may have some unique sources and, therefore, may require special attention [5]. In smaller (i.e., house size) buildings, renewable sources are already the primary mechanism for providing ventilation. Infiltration and natural ventilation are the predominant mechanisms for providing residential ventilation for these smaller buildings.

Ventilation is the building service most associated with controlling the indoor air quality to provide a healthy and comfortable environment. In large buildings ventilation is normally supplied through mechanical systems, but in smaller ones, such as single-family homes, it is principally supplied by leakage through the building envelope, i.e., infiltration, which is a renewable resource, albeit unintendedly so. Ventilation can be defined as the process by which clean air is provided to a space. It is needed to meet the metabolic requirements of occupants and to dilute and remove pollutants emitted within a space. Usually, ventilation air must be conditioned by heating or cooling in order

to maintain thermal comfort and, hence, becomes an energy liability. Indeed, ventilation energy requirements can exceed 50% of the conditioning load in some spaces [5]. Thus, excessive or uncontrolled ventilation can be a major contributor to energy costs and global pollution. Therefore, in terms of cost, energy, and pollution, efficient ventilation is essential. On the other hand, inadequate ventilation can cause comfort or health problems for the occupants.

Good indoor air quality may be defined as air, which is free of pollutants that cause irritation, discomfort or ill health to occupants [6]. Since long time is spent inside buildings, considerable effort has focused on developing methods to achieve an optimum indoor environment. An almost limitless number of pollutants may be present in a space, of which many are at virtually immeasurably low concentrations and have largely unknown toxicological effects [6]. The task of identifying and assessing the risk of individual pollutants has become a major research activity [e.g., [6, 7]. In reality, a perfectly pollutants-free environment is unlikely to be attained. Some pollutants can be tolerated at low concentrations, while irritation and odour often provide an early warning of deteriorating conditions. Health related air quality standards are typically based on risk assessment and are either specified in terms of maximum-permitted concentrations or a maximum allowed dose. Higher concentrations of pollutants are normally permitted for short-term exposure than are allowed for long-term exposure [7].

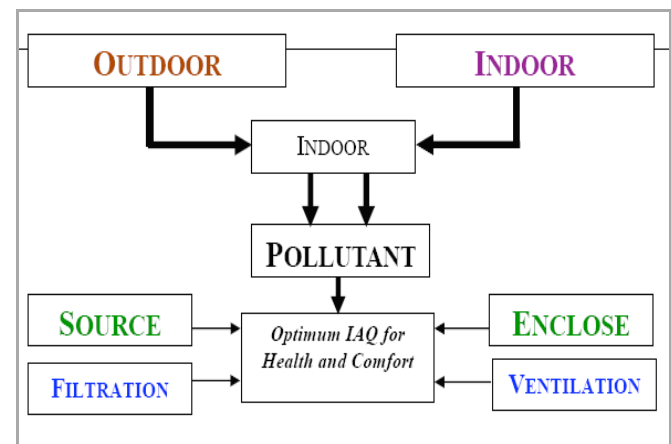

Figure 1: Strategies for controlling IAQ [6].

Ventilation is essential for securing a good indoor air quality, but, as explained earlier, can have a dominating influence on energy consumption in buildings. Air quality problems are more likely to occur if air supply is restricted. Probably a ventilation rate

averaging 7 l/s.p represents a minimum acceptable rate for normal odour and comfort requirements in office type buildings [8]. Diminishing returns are likely to be experienced at rates significantly above 10 l/s.p [8]. If air quality problems still persist, the cause is likely to be poor outdoor air quality (e.g., the entrainment of outdoor traffic fumes), poor air distribution or the excessive release of avoidable pollutants into space. However, the energy efficiency of ventilation can be improved by introducing exhaust air heat recovery, ground pre-heating, demand controlled ventilation, displacement ventilation and passive cooling [9]. In each case, a very careful analysis is necessary to ensure that the anticipated savings are actually achievable. Also, it is essential to differentiate between avoidable and unavoidable pollutant emissions. Achieving energy efficiency and optimum Indoor Air Quality (IAQ) depends on minimising the emission of avoidable pollutants. Pollutants inside greenhouses are derived from both indoor and outdoor contaminant sources, as illustrated in Figure 1. Each of these tends to impose different requirements on the control strategies needed to secure good health and comfort conditions.

3. ACHIEVING ENERGY EFFICIENT VENTILATION

A recent review of the International Energy Agency [10] concludes that the thermal insulation characteristics of buildings improve; ventilation and air movement is expected to become the dominant heating and cooling loss mechanism in buildings of the next century. Poor air quality in buildings sometimes manifests itself; refer to a range of symptoms that an occupant can experience while present in the building. Typical symptoms include lethargy, headaches, lack of concentration, runny nose, dry throat and eye and skin irritation [10]. Other examples of sick building syndrome have been associated with the presence of specific pollutants, such as outdoor fumes entering through air intakes [11]. Improved ventilation is one way of tackling the problem. Many standards are being introduced to ensure the adequacy and efficiency of ventilation. However, to be effective, standards need to address the minimum requirements of comfort, operational performance, air tightness, provision for maintenance and durability [12]. Also, various methods have been introduced to improve the energy performance of ventilation. These include:

3.1. Thermal Recovery

Recovery of thermal energy from the exhaust air stream is possible by means of air-to-air heat recovery

systems or heat pumps. In theory, such methods can recover as much as 70% of the waste heat [13]. While these methods are exceedingly popular, their full potential is, often, not achieved. This is because buildings or ductwork are often excessively leaky and, hence, additional electrical energy load is needed. To be successful, the designer must integrate such ventilation design with that of the building itself and be thoroughly aware of all the energy paths [13].

3.2. Ground Pre-Conditioning

Ventilation air can be pre-conditioned by passing the supply air ducts under-ground. This can provide a good measure of winter pre-heating and summer pre-cooling [14].

3.3. Demand Control Ventilation

Demand control ventilation, DCV, systems provide a means by which the rate of ventilation is modulated in response to varying air quality conditions. This is effective if a dominant pollutant is identifiable. In transiently occupied buildings, control by metabolic carbon dioxide concentration has become popular although must be introduced with caution. For success, it is essential to ensure that no other problem pollutants are present [15].

3.4. Displacement Ventilation

Displacement ventilation involves distributing clean air at low velocity and at a temperature of approximately 16°C below the ambient air temperature of the space [16]. This dense air mass moves at floor level until it reaches a thermal source such as an occupant or electric equipment, causing the air to warm and gently rise. Polluted air is then collected and extracted above the breathing zone. This process reduces the mixing effect of classical dilution ventilation, thus reducing the amount of ventilation needed to achieve the same air quality in the vicinity of occupants [16]. For success, very careful temperature control is needed and there is a limit on potential cooling capacity [16].

4. OUTDOORS AIR POLLUTION

Clean outdoor air is essential for good indoor air quality. Although air cleaning is possible, it is costly and not effective in the many offices and dwellings that are naturally ventilated, leaky or ventilated by mechanical extract systems. Some air quality problems are global and can only be controlled by international effort. Other

pollutants are much more regional and may be associated with local industry and traffic. Nature, too, presents its own problems with large volumes of dust and gaseous emissions being associated with volcanic activity. Similarly, while naturally occurring, radon can penetrate buildings from the underlying geological strata. Even rural areas are not immune to pollution, where the presence of pollen, fungal spores and agricultural chemicals can result in poor health and cause allergic reactions. There are several pollution control strategies.

Some of them are discussed below:

4.1. Filtration

Filtration is applied primarily to remove particulates from the air. Filtration of outdoor air cannot be readily applied to the many buildings that are naturally ventilated or excessively leaky. To be effective, filtration systems must be capable of trapping the smallest of particles and of handling large volumes of airflow. Activated carbon and other absorbing filters are additionally able to remove gaseous pollutants [17]. Mechanical systems in residential buildings contribute little to the ventilation rate. The thermal comfort is an important aspect of human life.

4.2. Positioning of Air Intakes

Air intakes must be located away from pollutant sources. Particular sources include street level and car parking locations [17]. Although urban air quality is normally much improved at elevations above street level, contamination from adjacent exhaust stacks and cooling towers must, also, be avoided [17]. Determining the optimum position for air intakes may require extensive wind tunnel or fluid dynamics analysis. Further information on the positioning of air intakes is reviewed by Limb 1995 [7].

4.3. Air Quality Controlled Fresh Air Dampers

Traffic pollution in urban areas is often highly transient, with peaks occurring during the morning and evening commuting periods. At these times, it may be possible to improve indoor air quality by temporarily closing fresh air intakes and windows.

4.4. Building Air Tightness

None of the above control strategies will be effective unless the building is well sealed from the outdoor environment to prevent contaminant ingress through air

infiltration. Underground parking garages must also be well sealed from occupied accommodation above. Evidence suggests that sealing is often inadequate [17].

5. INDOOR POLLUTANTS

Pollutants emitted inside buildings are derived from metabolism (odour, carbon dioxide, and bacteria), the activities of occupants (e.g., smoking, washing and cooking), emissions from materials used in construction and furnishing and emissions from machinery and processes. The preferred order of control is discussed below:

5.1. Source Control

Once a pollutant has entered a space, it can, at best, only be diluted [18]. Avoidable pollutants should, therefore, be eliminated. This means restricting or, preferably, eliminating potentially harmful pollutant emissions.

5.2. Enclosing and Ventilating at Source

Pollutants generated as part of the activity of occupants are usually highly localised. Wherever possible, source control should be applied, combined with the use of local extractors [18].

5.3. General Ventilation

General ventilation of a space is needed to dilute and remove residual pollution primarily from unavoidable contaminant sources [18].

6. VENTILATION OF SPACES IN HUMID CLIMATE

The design of windows in modern buildings in a warm, humid climate can be influenced either by their use to provide physiological and psychological comfort *via* providing air and daylight to interior spaces or by using them to provide aesthetically appealing fenestration. Most spaces in modern buildings are not adequately ventilated and it is recommended that effort should be directed towards the use of windows to achieve physiological comfort. Evaluation of public housing has focused on four main aspects: economics, social and physical factors, and resident's satisfaction. However, information about the physiological characteristics of spaces in a warm humid climate will aid the design of appropriate spaces with respect to the development and adequate choice of building materials and appropriate use of suitable passive energy. In this

light there is a need to examine resident's satisfaction with respect to these physiological issues. Proper ventilation in a space is a primary factor in determining human health, comfort and well being of the occupants.

At present, getting a proper naturally ventilated space seems to be a difficult task. This is partly due to the specific environmental problems of high temperature, high humidity, low wind velocity, and variable wind direction- usually attributed to the warm humid climate, on the one hand, and the difficulty of articulating the design constraints of security, privacy and the desire of users for large spaces on the other hand. As pointed out by most researchers in the field of passive energy design, such as Givoni [18], Koenigsberger *et al.*, [19] Boulet [20] and Szokolay outdoors [22], the types of spaces most suited to this climate are spaces, which are cross-ventilated. This implies that these spaces must have openings at least on opposite sides of a wall, but this condition is difficult to achieve in view of the design constraints mentioned above. So in most cases, the option left to the designer is to have openings on a wall or openings on adjacent walls. The effectiveness of the above arrangement for effective ventilation of a space still depends on other parameters. Therefore, in order to optimise comfort in spaces in warm humid climate, there is a need to re-examine the factors affecting proper ventilation with respect to these design issues.

In order to be thermally comfortable in interior spaces, four environmental parameters, namely air temperature, relative humidity, mean radiant temperature and air velocity, need to be present in the space in adequate proportions outdoors [21]. In a warm, humid climate, the predominance of high humidity necessitates a corresponding steady, continuous breeze of medium air speed to increase the efficiency of sweat evaporation and to avoid discomfort caused by moisture on skin and clothes. Continuous ventilation is therefore the primary requirement for comfort [22]. From the above, it is apparent that the most important of these comfort parameters in a warm, humid climate is air velocity. It should, also, be noted that indoor air velocity depends on the velocity of the air outdoors [22]. The factors affecting indoor air movement are orientation of the building with respect to wind direction, effect of the external features of the openings, the position of openings in the wall, the size of the openings and control of the openings. Cross-ventilation is the most effective method of getting appreciable air movement in interior spaces in warm, humid climates. For comfort purposes, the indoor wind velocity should be set at between 0.15 and 1.5 m/s

[23]. A mathematical model based on analysis of the experimental results [24], which established the relationship between the average indoor and outdoor air velocities with the windows placed perpendicular to each other, was adapted to suit a warm, humid climate and is, usually, used to evaluate the spaces. The formula states that:

$$V_1 = 0.45 (1 - \exp^{-3.84x}) V_o \quad (1)$$

Where:

V_1 = average indoor velocity

x = ratio of window area to wall area

V_o = outdoor wind speed

6.1. Air Movement in Buildings

Natural ventilation is now considered to be one of the requirements for a low energy building designs. Until about three decades ago the majority of office buildings were naturally ventilated. With the availability of inexpensive fossil energy and the tendency to provide better indoor environmental control, there has been a vast increase in the use of air-conditioning in new and refurbished buildings. However, recent scientific evidence on the impact of refrigerants and air-conditioning systems on the environment has promoted the more conscious building designers to give serious considerations to natural ventilation in non-domestic buildings [25]. Two major difficulties that a designer has to resolve are the questions of airflow control and room air movement in the space. Because of the problem of scaling and the difficulty of representing natural ventilation in laboratory, most of the methods used for predicting the air movement in mechanically ventilated buildings are not very suitable for naturally ventilated spaces [26]. However, computational fluid dynamics (CFD) is now becoming increasingly used for the design of both mechanical and natural ventilation systems. Since a CFD solution is based on the fundamental flow and energy equations, the technique is equally applicable to a naturally ventilated space as well as a mechanically ventilated one, providing that a realistic representation of the boundary conditions are made in the solution.

6.2. Natural Ventilation

Generally, buildings should be designed with controllable natural ventilation. A very high range of natural ventilation rates is necessary so that the heat transfer rate between inside and outside can be

selected to suit conditions [26]. The ventilation rates required to control summertime temperatures are very much higher than these required to control pollution or odour. Any natural ventilation system that can control summer temperatures can readily provide adequate ventilation to control levels of odour and carbon dioxide production in a building. Theoretically, it is not possible to achieve heat transfer without momentum transfer and loss of pressure. However, Figures 2 and 3 show some ideas for achieving heat reclaim at low velocities. Such ideas work well for small buildings.

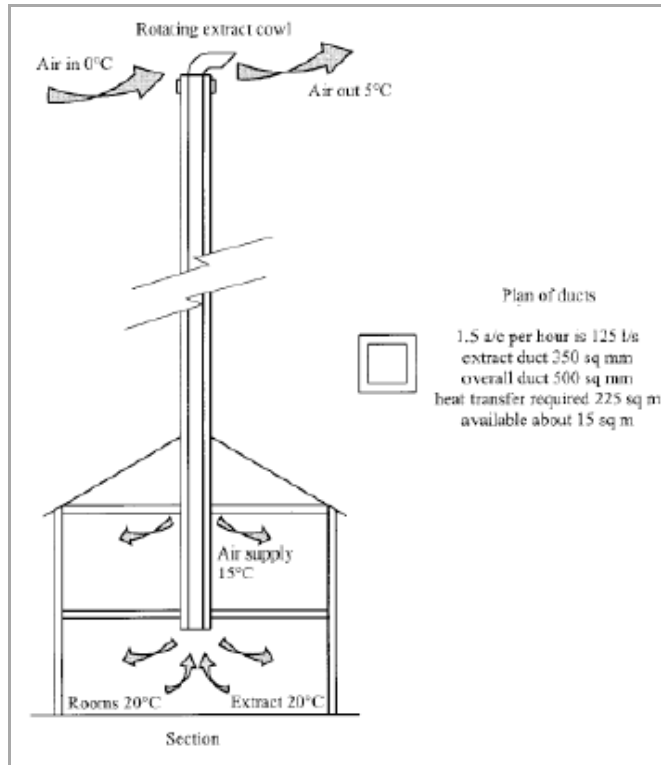

Figure 2: Small house natural ventilation with heat reclaims (A very tall chimney) [27].

6.3. Mechanical Ventilation

Most of the medium and large size buildings are ventilated by mechanical systems designed to bring in outside air, filter it, supply it to the occupants and then exhaust an approximately equal amount of stale air. Ideally, these systems should be based on criteria that can be established at the design stage. To return afterwards in attempts to mitigate problems may lead to considerable expense and energy waste, and may not be entirely successful [26]. The key factors that must be included in the design of ventilation systems are: code requirement and other regulations or standards (e.g., fire), ventilation strategy and systems sizing, climate and weather variations, air distribution, diffuser location and local ventilation, ease of operation and maintenance and impact of system on occupants (e.g., acoustically). These factors differ for various building types and occupancy patterns. For example, in office buildings, pollutants tend to come from sources such as occupancy, office equipment, and automobile fumes. Occupant pollutants typically include metabolic carbon dioxide emission, odours and sometimes smoking. When occupants (and not smoking) are the prime source. Carbon dioxide acts as a surrogate and can be used to cost-effectively modulate the ventilation, forming what is known as a demand controlled ventilation system. Generally, contaminant sources are varied but, often, well-defined and limiting values are often determined by occupational standards.

6.4. Bioclimatic Design

Bioclimatic design cannot continue to be a side issue of a technical nature to the main architectural design. In recent years started to alter course and to become much more holistic in its approach while trying to address itself to [27]:

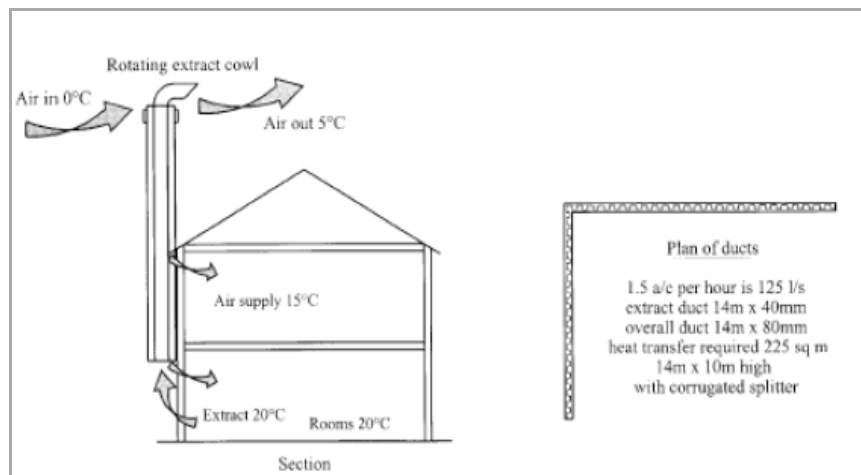

Figure 3: Ventilation duct supply and extract wraps around the building [27].

- The achievement of a sustainable development.
- The depletion of non-renewable sources and materials.
- The life cycle analysis of buildings.
- The total polluting effects of buildings on the environment.
- The reduction of energy consumption and
- Human health and comfort.

Hidden dimensions of architectural creation are vital to the notion of bioclimatic design. The most fundamental ones are [27]:

TIME, which has been called the fourth dimension of architectural space, is of importance because every object cannot exist but in time. The notion of time gives life to an object and releases it to periodic (predictable) or unperiodic repetition. Times relates to seasonal and diurnal patterns and thus to climate and the way that a building behaves or should be designed to couple with and not antagonise nature. It further releases to the dynamic nature of a building in contrast to the static image that we have created for it.

AIR, is a second invisible but important element. We create space and pretend that it is empty, oblivious of the fact that it is both surrounded by and filled with air. Air in its turn, due to air-movement, which is generated by either temperature or pressure differences, is very much there and alive. And related to the movement of air should be building shapes, sections, heights, orientations and the size and positioning of openings.

LIGHT, and in particular daylight, is a third important element. Architecture cannot exist but with light and from the time we have been able to substitute natural light with artificial lighting, many a building and a lot of architecture has become poorer so. It is not an exaggeration to say that the real form giver to architecture is not the architect himself but light and that the architect is but the forms moulder.

Vernacular architecture is beautiful to look at as well as significant to contemplate on. It is particularly interesting to realise the nature of traditional architecture where various devices to attain thermal comfort without resorting to fossil fuels can be seen. Sun shading and cross ventilation are two major concerns in house design and a south-facing façade is

mandatory to harness the sun in winter as much as possible. Natural ventilation required higher ceilings to bring a cooling effect to occupants in buildings built fifty years ago, whereas modern high technology buildings have lower ceiling heights, thus making air conditioning mandatory. Admitting the human right of enjoying modern lives with a certain level of comfort and convenience, it is necessary to consider how people can live and work in an ideal environment with the least amount of energy consumption in the age of global environment problems. People in the modern age could not put up with the poor indoor environment that people in the old age used to live in. In fact, in those days people had to live with the least amount of fuels readily available and to devise various means of constructing their houses so that they would be compatible with the local climate. It is important; therefore, in designing passive and low energy architecture for the future to learn from their spirit to overcome difficulties by having their creative designs adapted to respective regional climatic conditions and to try to devise the ecotechniques in combination with a high grade of modern science.

Heat gain in the summer is the main problem as it overheats the indoor environment of residential buildings. This forces the residents to utilise mechanical air conditioning systems to satisfy their comfort. Under today's economic crisis, energy conservation programmes and acts for respect of environment are receiving more attention. As a contribution to such efforts and in order to overcome the heat gain in houses, it is advisable to utilise passive systems, namely, producing ventilation by a solar chimney [28]. Room air is removed by ventilation produced by the metallic solar wall (MSW) as shown in Figure 4.

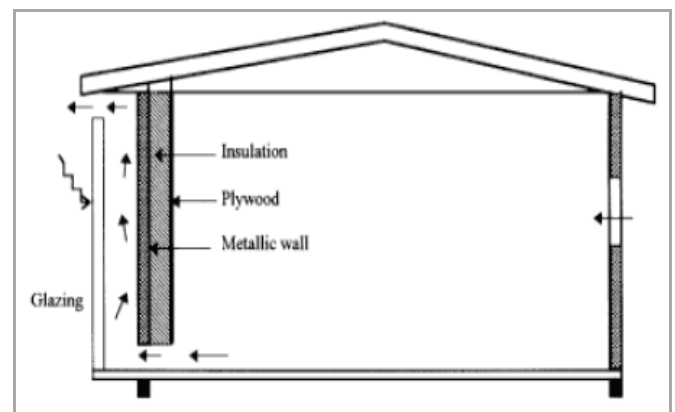

Figure 4: Schematic representations of the passive solar house and natural ventilation by metallic solar wall [28].

6.5. Infiltration

Infiltration is the process of air flowing in (or out) of leaks in the building envelope, thereby providing (renewable) ventilation in an uncontrolled manner [28]. All buildings are subject to infiltration, but it is more important in smaller buildings as many such buildings rely exclusively on infiltration when doors and windows are closed. In larger buildings there is less surface area to leak for a given amount of building volume, so the same leakage matters less. More importantly, the pressures in larger buildings are usually dominated by the mechanical system and the leaks in the building envelope have only a secondary impact on the ventilation rates [28]. Infiltration in larger buildings may, however, affect thermal comfort and control and systems balance. Typical minimum values of air exchange rates range from 0.5 to 1.0 h⁻¹ in office buildings [28]. Buildings with higher occupant density will have higher minimum outside air exchange rates when ventilation is based on outdoor air supply per occupant, typically 7 to 10 l s⁻¹ [28]. Thus, schools have minimum outdoor air ventilation rates 3 h⁻¹, while fully occupied theatres, auditoriums and meeting rooms may have minimum air exchange rates of 4 to 7 h⁻¹ [28]. It is in low-rise residential buildings (most typically, single-family houses) that infiltration is a dominant force. Mechanical systems in these buildings contribute little to the ventilation rate.

6.6. Passive Ventilation Systems

Passive solar systems for space heating and cooling, as well as passive cooling techniques can significantly contribute to energy saving in the building sector when used in combination with conventional systems for heating, cooling, ventilation and lighting. The overall thermal behaviour of the building is dependent on the alternatives and interventions made on the building's shell. Passive ventilation systems share the use of renewable energy to provide ventilation with infiltration. But unlike air leakage and open windows, passive ventilation systems are designed to provide specific amounts of ventilation to minimise both energy liabilities due to excessive ventilation and periods of poor air quality due to under-ventilation [29]. However, the most common passive ventilation system is the passive stack, which is normally used to extract air from kitchen and bathrooms. In this method, prevailing wind and temperature differences are used to drive airflow through a vertical shaft. Various stack designs can be used to control or enhance the performance, based on

local climate. However, careful design is required to avoid backdraughting and to insure proper mean rates. Although there is significant experience with this approach in Europe, it has been rarely used in North America [29].

Well-designed passive ventilation systems can be used to provide whole-building ventilation as well as local exhaust. Some efforts are currently underway to develop passive ventilation systems that incorporate heat recovery to minimise the need for conditioning the ventilation air [29]. These approaches aim towards a fully renewable ventilation system in that it requires no non-renewable resources for either providing the ventilation air or conditioning it. A traditional, naturally ventilated building can readily provide a high ventilation rate. On the other hand, the mechanical ventilation systems are very expensive. However, a comprehensive ecological concept can be developed to achieve a reduction of electrical and heating energy consumption and optimise natural air condition and ventilation.

6.7. Passive Cooling

In the office environment, high heat loads are commonly developed through lighting, computers and other electrical equipment. Further heat gains are developed through solar gains, occupants and high outdoor air temperature. Passive cooling methods attempt to reduce or eliminate the need for energy intensive refrigerative cooling by minimising heat gains. This involves taking advantage of thermal mass (night cooling) and introducing high levels of air change.

Night ventilation techniques seem to be the most appropriate strategy for buildings. This arises as a consequence of the large diurnal temperature range during the cooling seasons and the relatively low peak air temperatures, which occur during the day [30]. Such a combination allows the thermal mass of the building to use the cool night air to discard the heat absorbed during the day. An initial examination of the weather conditions experienced during the summer months of June to September in the UK indicates that most peak conditions of external weather fall within the ventilation and thermal mass edge of the bioclimatic chart [30]. Figure 5 shows that the summer (June to September) climatic envelope is within the heating, comfort, thermal mass and ventilation effectiveness areas of the chart. The key parameters influencing the effectiveness of night cooling are summarised into the following four categories [31]:

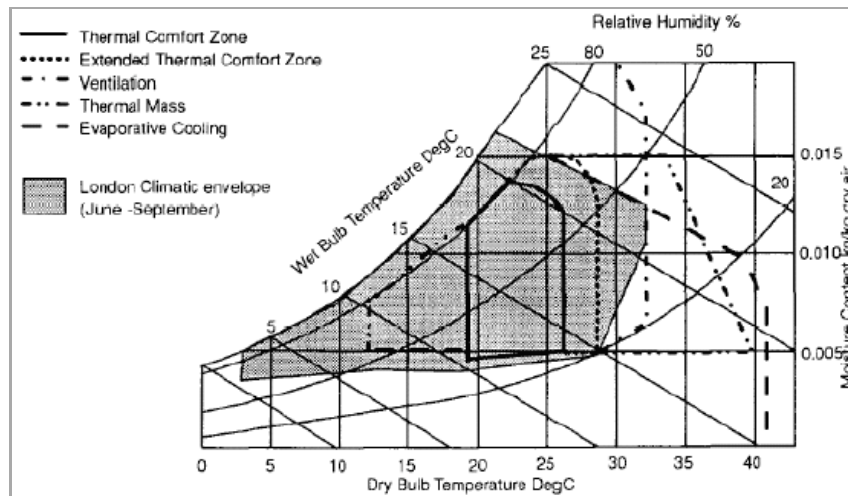

Figure 5: Bioclimatic chart with summer climatic envelope for London [32].

- Internal heat gains of 10, 25 and 40W/m²; representing occupancy only, occupancy plus lights, and occupancy together with lights and IT load respectively.
- Envelope gains.
- Thermal response.
- Ventilation gains/losses.

Due to the complexity resulting from all the interrelated parameters affecting the effectiveness of night ventilation, it is necessary for designers to have access to a simple user friendly and yet accurate model when assessing the viability of night ventilation during the initial design stage. The followings are the key output parameters [31]:

- Maximum dry resultant temperature during the occupied period.
- Dry resultant temperature at the start of the occupied period.
- Energy savings.

Maximising the efficiency and benefit gained from a greenhouse can be achieved using various approaches, employing different techniques that could be applied at the design, construction or operational stages [32]. Greenhouse cultivation is one of the most absorbing and rewarding form of gardening for anyone who enjoys growing plants [32]. The enthusiastic gardener can adapt the greenhouse climate to suit a particular group of plants, or raise flowers, fruit and vegetables out of their natural season. The comfort in greenhouse depends on many environmental

parameters. These include temperature, relative humidity, air quality and lighting. Although greenhouse and conservatory originally both meant a place to house or conserve greens (variegated hollies, cirrus, myrtles and oleanders), a greenhouse today implies a place in which plants are raised while conservatory usually describes a glazed room where plants may or may not play a significant role. Indeed, a greenhouse can be used for so many different purposes.

The input data required are the following [32]:

- Thermal gains related data: solar protection is assumed good, thermal gains can be varied and the user specifies the occupancy period.
- Building fabric data: glazing ratio can be any value while thermal mass can be varied at three levels.
- Ventilation data: infiltration, day ventilation and night ventilation can be specified as necessary.
- Weather data: solar data are fixed but temperature is user specified for seven days although temperature profiles need not be the same for all days. The weather data are specified in the form of maximum and minimum temperature for each day and hourly values are calculated by sinusoidal fitting.

However, a primary strategy for cooling buildings without mechanical intervention in hot humid climates is to promote natural ventilation. To control the energy used for the cooling of buildings in hot-arid regions with ambient air temperatures during the hottest period between 42 to 47°C, passive cooling approaches

should be implemented [32]. A solar chimney that employs convective currents to draw air out of the building could be used. By creating a hot zone with an exterior outlet, air can be drawn into the house, ventilating the structure as well as the occupants. Since solar energy in such a region is immense, the hot zone created with a black metal sheet on the glazing element can draw hotter air at a slightly higher speed [33]. Applications of solar chimneys in buildings were limited to external walls.

Integrating a solar chimney with an evaporatively cooled cavity could result in a better cooling effect. However, this should be applied with care since water sources are limited [33]. Figure 6 shows the combined wall-roof solar chimney incorporated into that building. Average room and ambient air temperatures are 23 and 27°C respectively. Air velocity required to achieve thermal comfort in the room should reach a maximum of 0.3m/s [33]. Figure 7 gives the cooling load versus air change per hour. This indicates that the inclined airflow by the combined wall-roof chimney is enough to overcome a high cooling load required to cool heavy residential buildings. This suggests that night ventilation could be improved, and incorporating a combined wall-roof solar chimney increases the cooling load. However, thermal mass and ventilation should be sufficient to cover cooling requirements in typical buildings. A high percentage of the cooling requirements can be met by night ventilation before another form of cooling is used. Finally, a simplified ventilation tool for assessing the applicability of night cooling in buildings, currently under development in terms of user inputs and typical outputs.

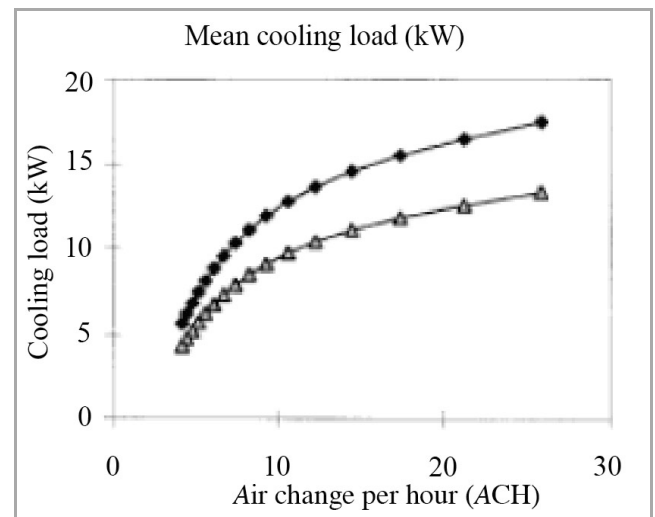

Figure 7: Cooling loads by night ventilation for desired room indoor air temperatures of 23 and 25°C [33].

7. AIR POLLUTANTS AND TRANSMUTATION

Controlling the pollution of the present civilisation is an increasing concern. More importance is given to control global carbon dioxide, which is considered to be the main factor of green house effect. Though the complete experimental result on the fact is yet to be debated, the immense heat, temperature and turbulence of nuclear explosion oxidising the atmospheric nitrogen into nitric oxide, are considered to be similarly responsible for depletion of ozone layer [34]. At present, more importance is given for plantation to reduce the level of global carbon dioxide. The plantation over the whole earth surface may control only 50% of carbon dioxide disposed to atmosphere and its greenhouse effect. There are, also, explosions in the ozone layer time to time to add to the problem. Irrespective of the relative importance of each factor,

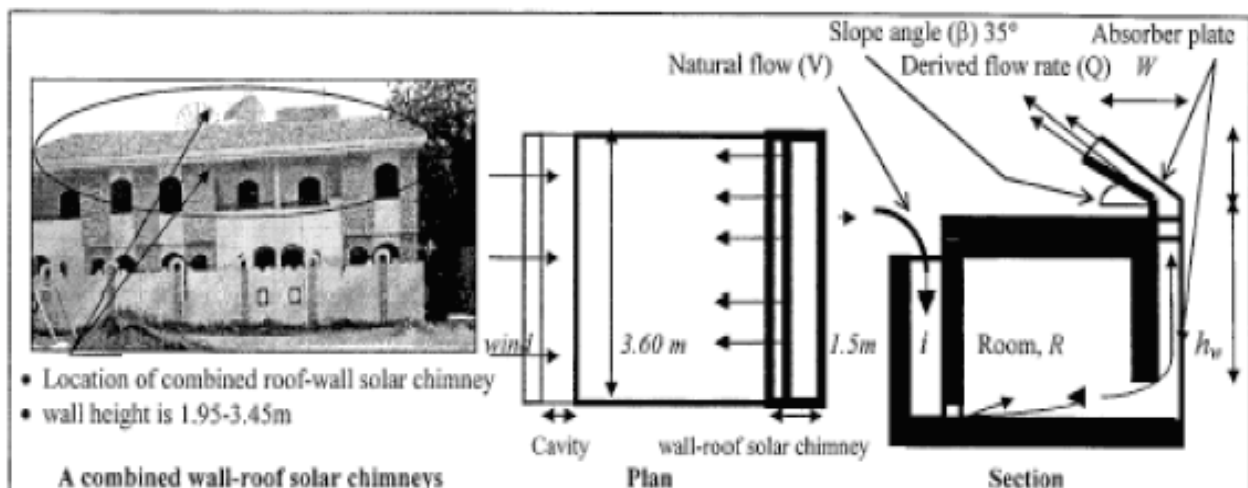

Figure 6: A combined wall-roof solar chimney incorporated into residential building Night ventilation [33].

the ozone layer protects us from harmful cosmic radiations and it is believed that the depletion of ozone layer increases the threat of outer radiations to human habitation if environmental pollution is not controlled or there is no possibility of self-sustainable stability in nature [34].

The presence of ionosphere in the outer-sphere is most probably for ionic dissociation of the gases of the outer-sphere in the presence of low pressure and cosmic radiation [34]. Moreover the ionosphere contains charged helium ions (alpha particle). Therefore, it may be concluded that the explosion in the ozone and transmission of radiations through it are the possible effects of transmutation of pollutants with exothermic reaction (emission of radiations) [34]. The existence of a black hole in the space, which is found in the photo camera of astrologist, is still unexplored. This black hole may be an effect of transmutation process with absorption of heat energy (endothermic reaction). The idea of transmutation of pollutants has been proposed for one or more of the following reasons [34]:

- The experimental results support the transmutation of materials.
- To search the sinks of the remaining carbon dioxide not absorbed by plants or seawater.
- To find out the possible causes of explosion in the ozone layer other than the depletion of ozone layer.
- To investigate the possibilities of the self-sustaining stability of global environment.

To prove the portability of transmutation of pollutants, experimental investigations may be conducted to bombard C or CO₂ or CH₄ or other air pollutants by accelerated alpha particles in a low-pressure vacuum tube in a similar condition of ionosphere. Heating them with gamma radiation can accelerate the alpha particles [34]. The results of such experimental investigation may prove the probable transmutation of pollutants and self-sustaining equilibrium of the global environment.

8. GREENHOUSES

Population growth and less availability of food material have become global concerns. The world population increases exponentially whereas food production has increased only arithmetically, meaning that the availability of food per capita has decreased.

This is more pronounced in the cases of oils, vegetables, fruits and milk, whereas it is marginal, rather than minimum, in cereals. The increase in population has also resulted in the use of more urban areas for habitation, less land available for cultivation and, hence, more food requirements. The resultant need is, therefore, to increase productivity and year round cultivation. To maximise production and meet the global demand on food, vegetables, flowers and horticultural crops, it is necessary to increase the effective production span of crops. The sun is the source of energy for plants and animals. This energy is converted into food (i.e., carbohydrates) by plants through a process called photosynthesis [35]. This process is accomplished at suitable atmospheric conditions. These conditions are provided by nature in different seasons and artificially by a greenhouse. The primary objective of greenhouses is to produce agricultural products outside the cultivation season. They offer a suitable microclimate for plants and make possible growth and fruiting, where it is not possible in open fields. This is why a greenhouse is also known as a "controlled environment greenhouse". Through a controlled environment, greenhouse production is advanced and can be continued for longer duration, and finally, production is increased [35]. The off-season production of flowers and vegetables is the unique feature of the controlled environment greenhouse. Hence, greenhouse technology has evolved to create the favourable environment, or maintaining the climate, in order to cultivate the desirable crop the year round. The use of "maintaining the climate" concept may be extended for crop drying, distillation, biogas plant heating and space conditioning. The use of greenhouses is widespread. During the last 10 years, the amount of greenhouses has increased considerably to cover up to several hundred hectares at present. Most of the production is commercialised locally or exported. In India, about 300 ha of land are under greenhouse cultivation. On the higher side, however, it is 98600 ha in Netherlands, 48000 ha in China and 40000 ha in Japan [36]. This shows that there is a large scope to extend greenhouse technology for various climates.

However, the effective utilisation of greenhouses has to deal with some specific climate problems like frost, during winter and overheating in summer days. These problems show the necessity of having a tool capable of predicting the thermal behaviour of a greenhouse under specific exterior conditions. Also, greenhouse industry has to deal with some problems

related to a poor design of a great number of greenhouses. Such problems are mostly related to, on the one hand, its incapacity to deal with the problem of frost, which in the cold clear sky days of winter can destroy the whole work of a season, and, on the other hand, the question of overheating in the summer days.

9. EFFECTS OF URBAN DENSITY

Compact development patterns can reduce infrastructure demands and the need to travel by car. As population density increases, transportation options multiply and dependence areas, per capita fuel consumption is much lower in densely populated areas because people drive so much less. Few roads and commercially viable public transport are the major merits [38]. On the other hand, urban density is a major factor that determines the urban ventilation conditions, as well as the urban temperature. Under given circumstances, an urban area with a high density of buildings can experience poor ventilation and strong heat island effect. In warm-humid regions these features would lead to a high level of thermal stress of the inhabitants and increased use of energy in air-conditioned buildings. With increasing urbanisation in the world, cities are growing in number, population and complexity. At present, 2% of the world's land surface is covered by cities, yet the people living in them consume 75% of the resources consumed by mankind [39]. The reality of modern urbanisation inevitably leads to higher densities than in traditional settlements and

this trend is particularly notable in developing countries. Today, the challenge before many cities to support large numbers of people while limiting their impact on the natural environment.

However, it is also possible that a high-density urban area, obtained by a mixture of high and low buildings, could have better ventilation conditions than an area with lower density but with buildings of the same height. Closely spaced or high-rise buildings are also affected by the use of natural lighting, natural ventilation and solar energy. If not properly planned, energy for electric lighting and mechanical cooling/ventilation may be increased and application of solar energy systems will be greatly limited. Table 1 gives a summary of the positive and negative effects of urban density.

All in all, denser city models require more careful design in order to maximise energy efficiency and satisfy other social and development requirements. Low energy design should not be considered in isolation, and in fact, it is a measure, which should work in harmony with other environmental objectives. Hence, building energy study provides opportunities not only for identifying energy and cost savings, but also for examining the indoor and outdoor environment.

9.1. Architectural Expression

The focus of the world's attention on environmental issues in recent years has stimulated response in many

Table 1: Effects of Urban Density on City's Energy Demand [40]

Positive Effects	Negative Effects
<p>Transport: Promote public transport and reduce the need for, and length of, trips by private cars.</p> <p>Infrastructure: Reduce street length needed to accommodate a given number of inhabitants. Shorten the length of infrastructure facilities such as water supply and sewage lines, reducing the energy needed for pumping.</p> <p>Thermal performance: Multi-story, multiunit buildings could reduce the overall area of the building's envelope and heat loss from the buildings. Shading among buildings could reduce solar exposure of buildings during the summer period.</p> <p>Energy systems: District cooling and heating system, which is usually more energy efficiency, is more feasible as density is higher.</p> <p>Ventilation: A desirable flow pattern around buildings may be obtained by proper arrangement of high-rise building blocks.</p>	<p>Transport: Congestion in urban areas reduces fuel efficiency of vehicles.</p> <p>Vertical transportation: High-rise buildings involve lifts, thus increasing the need for electricity for the vertical transportation.</p> <p>Ventilation: A concentration of high-rise and large buildings may impede the urban ventilation conditions.</p> <p>Urban heat island: Heat released and trapped in the urban areas may increase the need for air conditioning. The potential for natural lighting is generally reduced in high-density areas, increasing the need for electric lighting and the load on air conditioning to remove the heat resulting from the electric lighting.</p> <p>Use of solar energy: Roof and exposed areas for collection of solar energy are limited.</p>

countries, which have led to a closer examination of energy conservation strategies for conventional fossil fuels. Buildings are important consumers of energy and thus important contributors to emissions of greenhouse gases into the global atmosphere. The development and adoption of suitable renewable energy technology in buildings has an important role to play. A review of options indicates benefits and some problems [40]. There are two key elements to the fulfilling of renewable energy technology potential within the field of building design; first the installation of appropriate skills and attitudes in building design professionals and second the provision of the opportunity for such people to demonstrate their skills. This second element may only be created when the population at large and clients commissioning building design in particular, become more aware of what can be achieved and what resources are required. Terms like passive cooling or passive solar use mean that the cooling of a building or the exploitation of the energy of the sun is achieved not by machines but by the building's particular morphological organization. Hence, the passive approach to themes of energy savings is essentially based on the morphological articulations of the constructions. Passive solar design, in particular, can realise significant energy and cost savings. For a design to be successful, it is crucial for the designer to have a good understanding of the use of the building. Few of the buildings had performed as expected by their designers. To be more precise, their performance had been compromised by a variety of influences related to their design, construction and operation. However, there is no doubt that the passive energy approach is certainly the one that, being supported by the material shape of the buildings has a direct influence on architectural language and most greatly influences architectural expressiveness [40].

Furthermore, form is a main tool in architectural expression. To give form to the material things that one produces is an ineluctable necessity. In architecture, form, in fact, summarises and gives concreteness to its every value in terms of economy, aesthetics, functionality and, consequently, energy efficiency [40]. The target is to enrich the expressive message with forms producing an advantage energy-wise. Hence, form, in its geometric and material sense, conditions the energy efficiency of a building in its interaction with the environment. It is, then, very hard to extract and separate the parameters and the elements relative to this efficiency from the expressive unit to which they belong. By analysing energy issues and strategies by

means of the designs, of which they are an integral part, one will, more easily, focus the attention on the relationship between these themes, their specific context and their architectural expressiveness. Many concrete examples and a whole literature have recently grown up around these subjects and the wisdom of forms and expedients that belong to millennia-old traditions has been rediscovered. Such a revisiting, however, is only, or most especially, conceptual, since it must be filtered through today's technology and needs; both being almost irreconcilable with those of the past.

Two among the historical concepts are of special importance. One is rooted in the effort to establish rational and friendly strategic relations with the physical environment, while the other recognises the interactions between the psyche and physical perceptions in the creation of the feeling of comfort. The former, which may be defined as an alliance with the environment deals with the physical parameters involving a mixture of natural and artificial ingredients such as soil and vegetation, urban fabrics and pollution [40]. The most dominant outside parameter is, of course, the sun's irradiation, our planet's primary energy source. All these elements can be measured in physical terms and are therefore the subject of science. Within the second concept, however, one considers the emotional and intellectual energies, which are the prime inexhaustible source of renewable power [40]. In this case, cultural parameters, which are not exactly measurable, are involved. However, they represent the very essence of the architectural quality. Objective scientific measurement parameters tell us very little about the emotional way of perceiving, which influences the messages of human are physical sensorial organs.

The perceptual reality arises from a multitude of sensorial components; visual, thermal, acoustic, olfactory and kinaesthetics. It can, also, arise from the organisational quality of the space in which different parameters come together, like the sense of order or of serenity. Likewise, practical evaluations, such as usefulness, can be involved too. The evaluation is a wholly subjective matter, but can be shared by a set of experiencing persons [40]. Therefore, these cultural parameters could be different in different contexts in spite of the inexorable levelling on a planet-wide scale. However, the parameters change in the anthropological sense, not only with the cultural environment, but also in relation to function. The scientifically measurable

parameters can, thus, have their meanings very profoundly altered by the non-measurable, but describable, cultural parameters.

However, the low energy target also means to eliminate any excess in the quantities of material and in the manufacturing process necessary for the construction of our built environment. This claims for a more sober, elegant and essential expression, which is not jeopardising at all, but instead enhancing, the richness and preciousness of architecture, while contributing to a better environment from an aesthetic viewpoint [40]. Arguably, the most successful designs were in fact the simplest. Paying attention to orientation, plan and form can have far greater impact on energy performance than opting for elaborate solutions [40]. However, a design strategy can fail when those responsible for specifying materials for example, do not implement the passive solar strategy correctly.

Similarly, cost-cutting exercises can seriously upset the effectiveness of a design strategy. Therefore, it is imperative that a designer fully informs key personnel, such as the quantity surveyor and client, about their design and be prepared to defend it. Therefore, the designer should have an adequate understanding of how the occupants or processes, such as ventilation, would function within the building. Thinking through such processes in isolation without reference to others can lead to conflicting strategies, which can have a detrimental impact upon performance. Likewise, if the design intent of the building is not communicated to its occupants, there is a risk that they will use it inappropriately, thus, compromising its performance. Hence, the designer should communicate in simple terms the actions expected of the occupant to control the building. For example, occupants should be well informed about how to guard against summer overheating. If the designer opted for a simple, seasonally adjusted control; say, insulated sliding doors were to be used between the mass wall and the internal space. The lesson here is that designers must be prepared to defend their design such that others appreciate the importance and interrelationship of each component. A strategy will only work if each individual component is considered as part of the bigger picture. Failure to implement a component or incorrect installation, for example, can lead to failure of the strategy and consequently, in some instances, the building may not liked by its occupants due to its poor performance.

9.2. Sustainable Practices

Within the last decade sustainable development and building practices have acquired great importance due to the negative impact of various development projects on the environment. In line with a sustainable development approach, it is critical for practitioners to create a healthy, sustainable built environment [40]. In Europe, 50% of material resources taken from nature are building-related, over 50% of national waste production comes from the building sector and 40% of energy consumption is building-related [40]. Therefore, more attention should be directed towards establishing sustainable guidelines for practitioners. Furthermore, the rapid growth in population has led to active construction that, in some instances, neglected the impact on the environment and human activities. At the same time, the impact on the traditional heritage, an often-neglected issue of sustainability, has not been taken into consideration, despite representing a rich resource for sustainable building practices.

Sustainability has been defined as the extent to which progress and development should meet the need of the present without compromising the ability of the future generations to meet their own needs [40]. This encompasses a variety of levels and scales ranging from economic development and agriculture, to the management of human settlements and building practices. This general definition was further developed to include sustainable building practices and management of human settlements. The following issues were addressed during the Rio Earth Summit in 1992 [40]:

- The use of local materials and indigenous building sources.
- Incentive to promote the continuation of traditional techniques, with regional resources and self-help strategies.
- Regulation of energy-efficient design principles.
- International information exchange on all aspects of construction related to the environment, among architects and contractors, particularly non-conventional resources.
- Exploration of methods to encourage and facilitate the recycling and reuse of building materials, especially those requiring intensive energy use during manufacturing, and the use of clean technologies.

The objectives of the sustainable building practices aim to [40]:

- Develop a comprehensive definition of sustainability that includes socio-cultural, bio-climate, and technological aspects.
- Establish guidelines for future sustainable architecture.
- Predict the CO₂ emissions in buildings.
- The proper architectural measure for sustainability is efficient, energy use, waste control, population growth, carrying capacity, and resource efficiency.
- Establish methods of design that conserve energy and natural resources.

A building inevitably consumes materials and energy resources. The technology is available to use methods and materials that reduce the environmental impacts, increase operating efficiency, and increase durability of buildings (Table 2).

Literature on green buildings reveals a number of principles that can be synthesised in the creation of the built environment that is sustainable. According to Lobo [14], these are: land development, building design and construction, occupant considerations, life cycle assessment, volunteer incentives and marketing

programmes, facilitate reuse and remodelling, and final disposition of the structure. These parameters and many more are essential for analysis, making them an important element of the design decision-making process. Today, architects should prepare for this as well as dealing with existing buildings with many unfavourable urban environmental factors, such as many spaces have no choice of orientation, and, often, set in noisy streets with their windows opening into dusty and polluted air and surrounding buildings overshadowing them.

9.3. Buildings and CO₂ Emission

To achieve carbon dioxide, CO₂, emission targets, more fundamental changes to building designs have been suggested [40]. The actual performance of buildings must also be improved to meet the emission targets. To this end, it has been suggested that the performance assessment should be introduced to ensure that the quality of construction, installation and commissioning achieve the design intent. Air-tightness and the commissioning of plant and controls are the main two elements of assessing CO₂ emission. Air-tightness is important as uncontrolled air leakage wastes energy. Uncertainties over infiltration rates are often the reason for excessive design margins that result in oversized and inefficient plants. On the other hand, commissioning to accept procedures would significantly improve energy efficiency. The slow turnover in the building stock means that improved

Table 2: Design, Construction and Environmental Control Description of Traditional and New Houses

Design Characteristics	Traditional Houses	New Houses
Form	Courtyard (height twice its width)-open to sky	Rectangle-closed
Construction	Brick walls 50cm thick, brick roof with no insulation in either	Brick walls 25cm thick, concrete roof-no insulation
Environmental control	Evaporative air coolers	Evaporative air coolers
Ease of climatic control	Difficult-rooms open into the climatically uncontrolled open courtyard	Moderate-rooms open into the enclosed internal corridor
Maintenance	Well conserved and maintained	New construction
Windows	Vertical and single glazing	Horizontal-single glazing
Urban morphology	Each house attached from 3 sides	Row houses attached from 2 sides
Orientation	Varies-irregular shapes and winding alleyways	North-south (row houses)
Orientation and solar gain	Solar gains less affected by orientation due to shading provided by the deep courtyard	Solar gain determined by orientation-no obstruction (shading)
Sharing solar gain	Significant - due to long-wave exchange or convective exchange between the 4 vertical walls surrounding the courtyard	Minimal- S-wall receives much more solar radiation than the N-wall due to the absence of any interreflection and long-wave exchange
Occupant's social status	Low income families	Low and middle income families

performance of new buildings will only cut CO₂ emissions significantly in the long term. Consequently, the performance of existing buildings must be improved. For example, improving 3% of existing buildings would be more effective in cutting emissions than, say, improving the fabric standards for new non-domestic buildings and improving the efficiency of new air conditioning and ventilation systems [40]. A reduction in emissions arising from urban activities can, however, only be achieved by a combination of energy efficiency measures and a move away from fossil fuels.

9.4. Energy Efficiency most Cost-effective

Energy efficiency is the most cost-effective way of cutting carbon dioxide emissions and improvements to households and businesses. It can also have many other additional social, economic and health benefits, such as warmer and healthier homes, lower fuel bills and company running costs and, indirectly, jobs. Britain wastes 20 per cent of its fossil fuel and electricity use. This implies that it would be cost-effective to cut £10 billion a year off the collective fuel bill and reduce CO₂ emissions by some 120 million tonnes. Yet, due to lack of good information and advice on energy saving, along with the capital to finance energy efficiency improvements, this huge potential for reducing energy demand is not being realised. Traditionally, energy utilities have been essentially fuel providers and the industry has pursued profits from increased volume of sales. Institutional and market arrangements have favoured energy consumption rather than conservation. However, energy is at the centre of the sustainable development paradigm as few activities affect the environment as much as the continually increasing use of energy. Most of the used energy depends on finite resources, such as coal, oil, gas and uranium. In addition, more than three quarters of the world's consumption of these fuels is used, often inefficiently, by only one quarter of the world's population. Without even addressing these inequities or the precious, finite nature of these resources, the scale of environmental damage will force the reduction of the usage of these fuels long before they run out.

Throughout the energy generation process there are impacts on the environment on local, national and international levels, from opencast mining and oil exploration to emissions of the potent greenhouse gas carbon dioxide in ever increasing concentration. Recently, the world's leading climate scientists reached an agreement that human activities, such as burning fossil fuels for energy and transport, are causing the world's temperature to rise. The Intergovernmental

Panel on Climate Change has concluded that "the balance of evidence suggests a discernible human influence on global climate". It predicts a rate of warming greater than any one seen in the last 10,000 years, in other words, throughout human history. The exact impact of climate change is difficult to predict and will vary regionally. It could, however, include sea level rise, disrupted agriculture and food supplies and the possibility of more freak weather events such as hurricanes and droughts. Indeed, people already are waking up to the financial and social, as well as the environmental, risks of unsustainable energy generation methods that represent the costs of the impacts of climate change, acid rain and oil spills. The insurance industry, for example, concerned about the billion dollar costs of hurricanes and floods, has joined sides with environmentalists to lobby for greenhouse gas emissions reduction. Friends of the earth are campaigning for a more sustainable energy policy, guided by the principle of environmental protection and with the objectives of sound natural resource management and long-term energy security. The key priorities of such an energy policy must be to reduce fossil fuel use, move away from nuclear power, improve the efficiency with which energy is used and increase the amount of energy obtainable from sustainable, renewable sources. Efficient energy use has never been more crucial than it is today, particularly with the prospect of the imminent introduction of the climate change levy (CCL). Establishing an energy use action plan is the essential foundation to the elimination of energy waste. A logical starting point is to carry out an energy audit that enables the assessment of the energy use and determine what actions to take. The actions are best categorised by splitting measures into the following three general groups:

(1) High priority/low cost:

These are normally measures, which require minimal investment and can be implemented quickly. The followings are some examples of such measures [40]:

- Good housekeeping, monitoring energy use and targeting waste-fuel practices.
- Adjusting controls to match requirements.
- Improved greenhouse space utilisation.
- Small capital item time switches, thermostats, etc.

- Carrying out minor maintenance and repairs.
- Staff education and training.
- Ensuring that energy is being purchased through the most suitable tariff or contract arrangements.

(2) Medium priority/medium cost:

Measures, which, although involve little or no design, involve greater expenditure and can take longer to implement. Examples of such measures are listed below [40]:

- New or replacement controls.
- Greenhouse component alteration e.g., insulation, sealing glass joints, etc.
- Alternative equipment components e.g., energy efficient lamps in light fittings, etc.

(3) Long term/high cost:

These measures require detailed study and design. They can be best represented by the followings [40]:

- Replacing or upgrading of plant and equipment.
- Fundamental redesign of systems e.g., CHP installations.

This process can often be a complex experience and therefore the most cost-effective approach is to employ an energy specialist to help.

Energy efficiency brings health, productivity, safety, comfort and savings to homeowners, as well as local and global environmental benefits. The use of renewable energy resources could play an important role in this context, especially with regard to responsible and sustainable development.

9.5. Policy Recommendations for a Sustainable Energy Future

Sustainability is regarded as a major consideration for both urban and rural development. People have been exploiting the natural resources with no consideration to the effects, both short-term (environmental) and long-term (resources crunch). It is also felt that knowledge and technology have not been used effectively in utilising energy resources. Energy is the vital input for economic and social development of any country. Its sustainability is an important factor to be considered. The urban areas depend, to a large extent, on commercial energy sources. The rural areas use non-commercial sources like firewood and agricultural wastes. With the present day trends for improving the quality of life and sustenance of mankind, environmental issues are considered highly important. In this context, the term energy loss has no significant technical meaning. Instead, the exergy loss has to be considered, as destruction of exergy is possible. Hence, exergy loss minimisation will help in sustainability. In the process of developing, there are two options to manage energy resources: (1) End use matching/demand side management, which focuses on the utilities. The mode of obtaining this is decided based on economic terms. It is, therefore, a

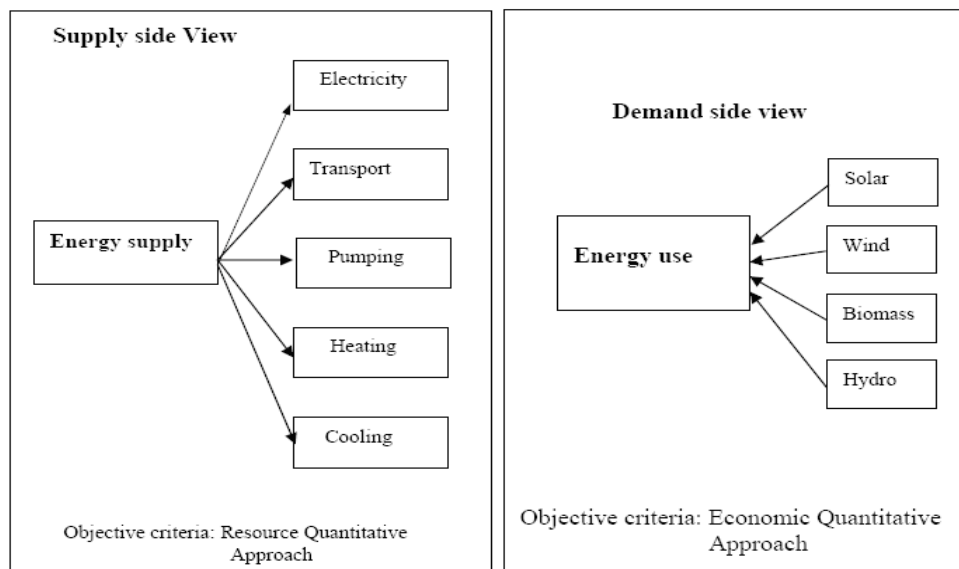

Figure 8: Supply side and demand side management approach for energy.

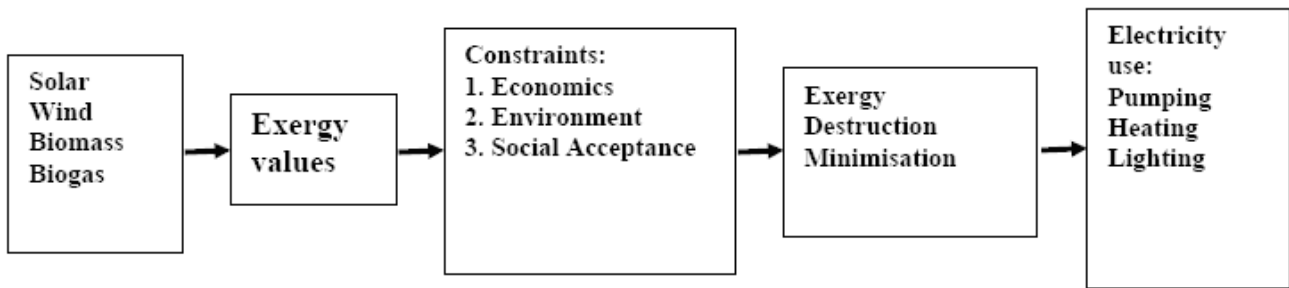

Figure 9: Exergy based optimal energy model.

quantitative approach. (2) Supply side management, which focuses on the renewable energy resource and methods of utilising it. This is decided based on thermodynamic consideration having the resource-user temperature or exergy destruction as the objective criteria. It is, therefore, a qualitative approach. The two options are explained schematically in Figure 8. The exergy-based energy, developed with supply side perspective is shown in Figure 9.

The following policy measures had been identified [40]:

- Clear environmental and social objectives for energy market liberalisation, including a commitment to energy efficiency and renewables.
- Economic, institutional and regulatory frameworks, which encourage the transition to total energy services, and economic measures to encourage utility investment in energy efficiency (e.g., levies on fuel bills).
- Incentives for demand side management, including grants for low-income households, expert advice and training, standards for appliances and buildings and tax incentives.
- Research and development funding for renewable energy technologies not yet commercially viable.
- Continued institutional support for new renewables (such as standard cost-reflective payments and obligation on utilities to buy).
- Ecological tax reform to internalise external environmental and social costs within energy prices.
- Planning for sensitive development and public acceptability for renewable energy.

Energy resources are needed for societal development. Their sustainable development requires a supply of energy resources that are sustainably available at a reasonable cost and can cause no negative societal impacts. Energy resources such as fossil fuels are finite and lack sustainability, while renewable energy sources are sustainable over a relatively longer term. Environmental concerns are also a major factor in sustainable development, as activities, which degrade the environment, are not sustainable. Hence, as much as environmental impact is associated with energy, sustainable development requires the use of energy resources, which cause as little environmental impact as possible. One way to reduce the resource depletion associated with cycling is to reduce the losses that accompany the transfer of exergy to consume resources by increasing the efficiency of exergy transfer between resources i.e., increasing the fraction of exergy removed from one resource that is transferred to another [40].

As explained above, exergy efficiency may be thought of as a more accurate measure of energy efficiency that accounts for quantity and quality aspects of energy flows. Improved exergy efficiency leads to reduced exergy losses. Most efficiency improvements produce direct environmental benefits in two ways. First, operating energy input requirements are reduced per unit output, and pollutants generated are correspondingly reduced. Second, consideration of the entire life cycle for energy resources and technologies suggests that improved efficiency reduces environmental impact during most stages of the life cycle. Quite often, the main concept of sustainability, which often inspires local and national authorities to incorporate environmental consideration into setting up energy programmes have different meanings in different contexts though it usually embodies a long-term perspective. Future energy systems will largely be shaped by broad and powerful trends that have their roots in basic human needs. Combined with increasing

world population, the need will become more apparent for successful implementation of sustainable development.

Heat has a lower exergy, or quality of energy, compared with work. Therefore, heat cannot be converted into work by 100% efficiency. Some examples of the difference between energy and exergy are shown in Table 3.

Table 3: Qualities of Various Energy Sources

Source	Energy (J)	Exergy (J)	CQF
Water at 80°C	100	16	0.16
Steam at 120°C	100	24	0.24
Natural gas	100	99	0.99
Electricity/work	100	100	1.00

The terms used in Table 3 have the following meanings:

$$\text{Carnot Quality Factor (CQF)} = (1 - T_o/T_s) \quad (2)$$

$$\text{Exergy} = \text{Energy (transferred)} \times \text{CQF} \quad (3)$$

Where T_o is the environment temperature (°K) and T_s is the temperature of the stream (°K).

Various parameters are essential to achieving sustainable development in a society. Some of them are as follows [40]:

- Public awareness
- Information
- Environmental education and training
- Innovative energy strategies
- Renewable energy sources and cleaner technologies
- Financing
- Monitoring and evaluation tools.

Implementation of greenhouses offers a chance for maintenance and repair services. It is expected that the pace of implementation will increase and the quality of work improve in addition to building the capacity of the private and district staff in contracting procedures. The financial accountability is important and should be made transparent. The development of a renewable

energy in a country depends on many factors. Those important to success are listed below:

(1) Motivation of the population

The population should be motivated towards awareness of high environmental issues, rational use of energy in order to reduce cost. Subsidy programme should be implemented as incentives to install renewable energy plants. In addition, image campaigns to raise awareness of renewable technology [40].

(2) Technical product development

To achieve technical development of renewable energy technologies the following should be addressed [40]:

- Increasing the longevity and reliability of renewable technology
- Adapting renewable technology to household technology (hot water supply)
- Integration of renewable technology in heating technology
- Integration of renewable technology in architecture, e.g., in the roof or façade
- Development of new applications, e.g., solar cooling
- Cost reduction.

(3) Distribution and sales

Commercialisation of renewable energy technology requires [40]:

- Inclusion of renewable technology in the product range of heating trades at all levels of the distribution process (wholesale, retail)
- Building distribution nets for renewable technology
- Training of personnel in distribution and sales
- Training of field sales force

(4) Consumer consultation and installation

To encourage all sectors of the population to participate in adoption of renewable energy technologies, the following has to be realized [40]:

- Acceptance by craftspeople, marketing by them
- Technical training of craftspeople, initial and follow-up training programmes
- Sales training for craftspeople
- Information material to be made available to craftspeople for consumer consultation

(5) Projecting and planning

Successful application of renewable technologies also requires [40]:

- Acceptance by decision makers in the building sector (architects, house technology planners, etc.)
- Integration of renewable technology in training
- Demonstration projects/architecture competitions
- Renewable energy project developers should prepare to participate in the carbon market by:
 - Ensuring that renewable energy projects comply with Kyoto Protocol requirements.
 - Quantifying the expected avoided emissions.
 - Registering the project with the required offices.
 - Contractually allocating the right to this revenue stream.

Other ecological measures employed on the development include [40]:

- Simplified building details.
- Reduced number of materials.
- Materials that can be recycled or reused.
- Materials easily maintained and repaired.
- Materials that do not have a bad influence on the indoor climate (i.e., non-toxic).
- Local cleaning of grey water.
- Collecting and use of rainwater for outdoor purposes and park elements.
- Building volumes designed to give maximum access to neighbouring park areas.

- All apartments have visual access to both backyard and park.

(6) Energy saving measures

The following energy saving measures should also be considered [40]:

- Building integrated solar PV system.
- Day-lighting.
- Ecological insulation materials.
- Natural/hybrid ventilation.
- Passive cooling.
- Passive solar heating.
- Solar heating of domestic hot water.
- Utilisation of rainwater for flushing.

Improving access for rural and urban low-income areas in developing countries through energy efficiency and renewable energies. Sustainable energy is a prerequisite for development. Energy-based living standards in developing countries, however, are clearly below standards in developed countries. Low levels of access to affordable and environmentally sound energy in both rural and urban low-income areas are therefore a predominant issue in developing countries. In recent years many programmes for development aid or technical assistance have been focusing on improving access to sustainable energy, many of them with impressive results [40].

Apart from success stories, however, experience also shows that positive appraisals of many projects evaporate after completion and vanishing of the implementation expert team. Altogether, the diffusion of sustainable technologies such as energy efficiency and renewable energies for cooking, heating, lighting, electrical appliances and building insulation in developing countries has been slow.

Energy efficiency and renewable energy programmes could be more sustainable and pilot studies more effective and pulse releasing if the entire policy and implementation process was considered and redesigned from the outset. New financing and implementation processes are needed which allow reallocating financial resources and thus enabling countries themselves to achieve a sustainable energy

infrastructure. The links between the energy policy framework, financing and implementation of renewable energy and energy efficiency projects have to be strengthened, and capacity building efforts are required [40].

10. GREENHOUSE ENVIRONMENT

The comfort in a greenhouse depends on many environmental parameters. These include temperature, relative humidity, air quality and lighting. Although greenhouse and conservatory originally both meant a place to house or conserve greens (variegated hollies, cirrus, myrtles and oleanders), a greenhouse today implies a place in which plants are raised while conservatory usually describes a glazed room where plants may or may not play a significant role [40]. Indeed, a greenhouse can be used for so many different purposes. It is, therefore, difficult to decide how to group the information about the plants that can be grown inside it. Whereas heat loss in winter a problem, it can be a positive advantage when greenhouse temperatures soar considerably above outside temperatures in summer. Indoor relative humidity control is one of the most effective long-term mite control measures. There are many ways in which the internal relative humidity can be controlled including the use of appropriate ventilation, the reduction of internal moisture production and maintenance of adequate internal temperatures through the use of efficient heating and insulation.

The introduction of a reflecting wall at the back of a greenhouse considerably enhances the solar radiation that reaches the ground level at any particular time of the day. The energy yield of the greenhouse with any type of reflecting wall was also significantly increased. The increase in energy efficiency was obtained by

calculating the ratio between the total energy received during the day in greenhouse with a reflecting wall, compared to that in a classical greenhouse. Hence, the energy balance was significantly shifted towards conservation of classical energy for heating or lighting. The four-fold greater amount of energy that can be captured by virtue of using a reflecting wall with an adjustable inclination and louvers during winter attracts special attention. When sky (diffuse) radiation that was received by the ground in amounts shown in Figure 10, were taken into account, the values of the enhancement coefficients were reduced to some extent: this was due to the fact that they added up to the direct radiation from the sun in both new and classical greenhouses. However, this is a useful effect as further increases overall energy gain. There is also an ironing out effect expressed in terms of the ratios between peak and average insulations.

Finally, the presented theory can be used to calculate the expected effects of the reflecting wall at any particular latitude, under different weather conditions, and when the average numbers of clear days are taken into account. Thereby an assessment of the cost of a particular setup can be obtained. Under circumstances of a few clear days, it may still be worthwhile from a financial point of view to turn a classical greenhouse into one with a reflecting wall by simply covering the glass wall on the north-facing side with aluminum foil with virtually negligible expenditure.

10.1. Relative Humidity

Air humidity is measured as a percentage of water vapour in the air on a scale from 0% to 100%, where 0% being dry and 100% being full saturation level. The main environmental control factor for dust mites is relative humidity. The followings are the practical

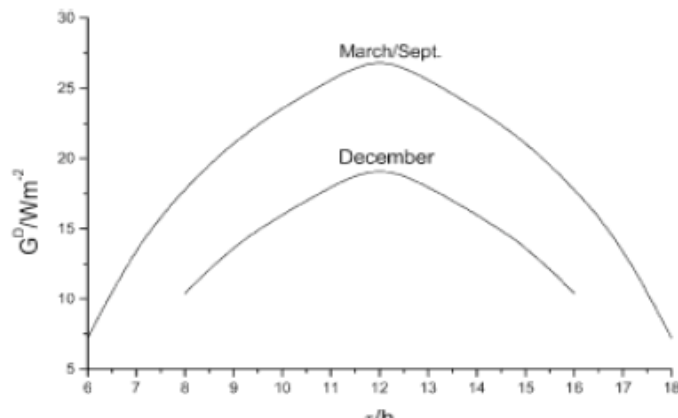

Figure 10: Ground irradiance from diffuse (sky) radiation from a clear sky at the shortest winter day and at equinox [38].

methods of controlling measures available for reducing dust mite populations:

- Chemical control.
- Cleaning and vacuuming.
- Use of electric blankets, and
- Indoor humidity.

10.2. Ground Radiation

Reflection of sunrays is mostly used for concentrating them onto reactors of solar power plants. Enhancing the insolation for other purposes has, so far, scarcely been used. Several years ago, application of this principle for increasing the ground irradiance in greenhouses, glass covered extensions in buildings, and for illuminating northward facing walls of buildings was proposed (Omer, 2015). Greenhouse and base with horticultural glass as shown in Figure 11.

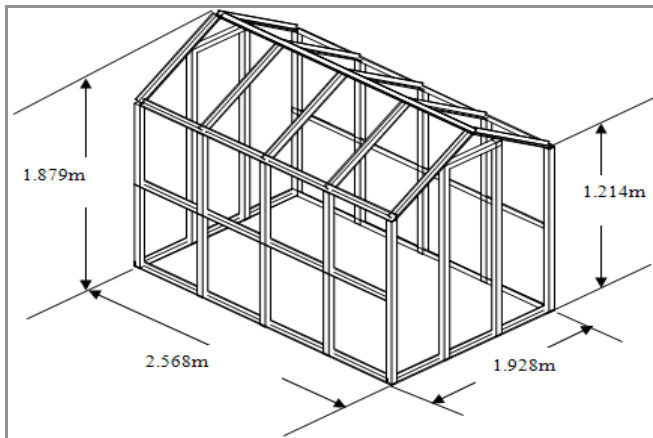

Figure 11: Greenhouse and base with horticultural glass [40].

Application of reflection of sun's rays was motivated by the fact that ground illuminance/irradiance from direct sunlight is of very low intensity in winter months, even when skies are clear, due to the low incident angle of incoming radiation during most of the day. This is even more pronounced at greater latitudes. As can be seen in Figure 12, which depicts a sunbeam split into its vertical and horizontal components, nearly all of the radiation passes through a greenhouse during most of the day.

10.3. Greenhouse Environment

It has been known for long time now that urban centres have mean temperatures higher than their less developed surroundings. The urban heat increases the average and peak air temperatures, which, in turn, affect the demand for heating and cooling. Higher temperatures can be beneficial in the heating season, lowering fuel use, but they exacerbate the energy demand for cooling in summer time. In temperate climates neither heating nor cooling may dominate the fuel use in a building, and the balance of the effect of the heat is less. The solar gains, however, would affect the energy consumption. Therefore, lower or higher percentage of glazing, or incorporating of shading devices might affect the balance between annual heating and cooling load. As the provision of cooling is expensive with higher environmental cost, ways of using innovative alternative systems like mop fans will be appreciated (Figures 13-15).

Indeed, considerable research activities have been devoted to the development of alternative methods of refrigeration and air-conditioning. The mop fan is a novel air-cleaning device that fulfils the functions of de-dusting of gas streams, removal of gaseous contaminations from gas streams and gas circulation

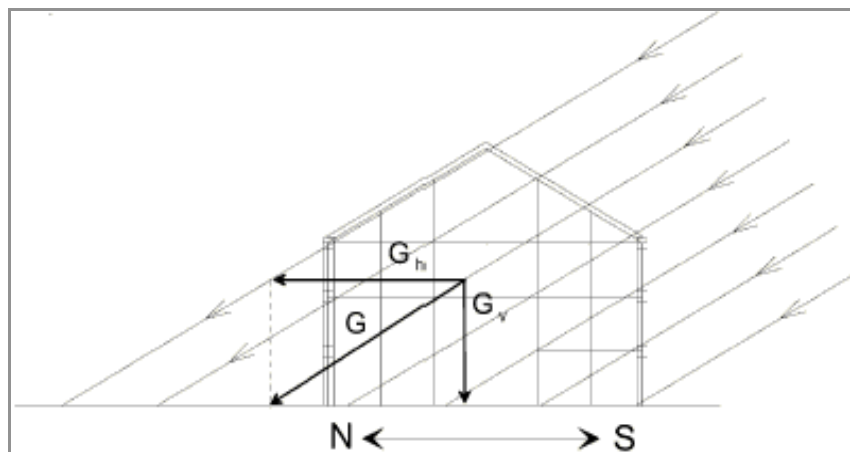

Figure 12: Relative horizontal and vertical components of solar radiation.

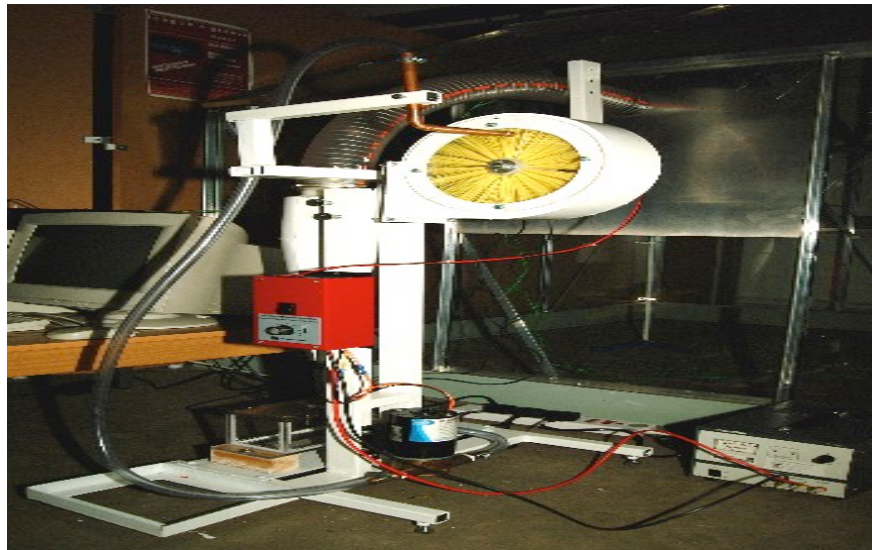

Figure 13: Mop fan system.

(Omer, 2015). Hence, the mop fan seems particularly suitable for applications in industrial, agricultural and commercial buildings and greenhouses.

temperature and a lower ambient relative humidity lead to a higher COP. This means that the system will be, in



Figure 14: Mop fan in greenhouse.



Figure 15: Plants in greenhouse.

Indoor conditions are usually fixed by comfort conditions, with air temperatures ranging from 15°C to 27°C, and relative humidities ranging from 50% to 70% (Omer, 2015). The system performance (COP) is defined as the ration between the cooling effect in the greenhouse and the total amount of air input to the mop fan. Hence (Omer, 2015),

$$\text{COP} = \text{Cooling delivered/air input to the mop fan} \quad (3)$$

Therefore, system performance (COP) varies with indoor and outdoor conditions. A lower ambient

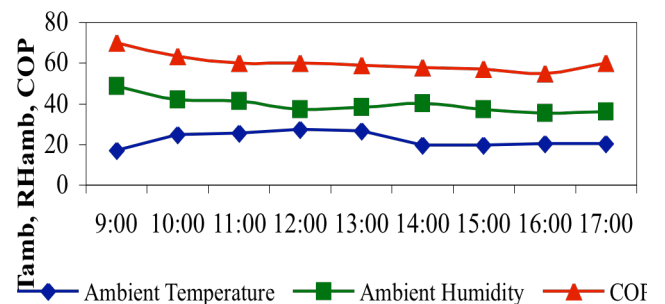

Figure 16: Ambient temperature, relative humidity and COP.

principle, more efficient in colder and drier climates. The effect of indoor (greenhouse) conditions and outdoor (ambient) conditions (temperature and relative humidity) on system performance is illustrated in Figure 16.

CONCLUSIONS

Thermal comfort is an important aspect of human life. Buildings where people work require more light than buildings where people live. In buildings where people live the energy is used for maintaining both the temperature and lighting. Hence, natural ventilation is rapidly becoming a significant part in the design strategy for non-domestic buildings because of its potential to reduce the environmental impact of building operation, due to lower energy demand for cooling. A traditional, naturally ventilated building can readily provide a high ventilation rate. On the other hand, the mechanical ventilation systems are very expensive. However, a comprehensive ecological concept can be developed to achieve a reduction of electrical and heating energy consumption, optimise natural air condition and ventilation, improve the use of daylight and choose environmentally adequate building materials. Plants, like human beings, need tender loving care in the form of optimum settings of light, sunshine, nourishment, and water. Hence, the control of sunlight, air humidity and temperatures in greenhouses are the key to successful greenhouse gardening. The mop fan is a simple and novel air humidifier; which is capable of removing particulate and gaseous pollutants while providing ventilation. It is a device ideally suited to greenhouse applications, which require robustness, low cost, minimum maintenance and high efficiency. A device meeting these requirements is not yet available to the farming community. Hence, implementing mop fans aids sustainable development through using a clean, environmentally friendly device that decreases load in the greenhouse and reduces energy consumption.

Hence, the control of sunlight, air humidity and temperatures in greenhouses are the key to successful greenhouse gardening. The mop fan is a simple and novel air humidifier; which is capable of removing particulate and gaseous pollutants while providing ventilation. It is a device ideally suited to greenhouse applications, which require robustness, low cost, minimum maintenance and high efficiency. A device meeting these requirements is not yet available to the farming community.

Hence, implementing mop fans aids sustainable development through using a clean, environmentally friendly device that decreases load in the greenhouse and reduces energy consumption.

REFERENCES

- [1] Jeremy L. The energy crisis, global warming and the role of renewables. *Renewable Energy World* 2005; 8(2).
- [2] Omer A. Low energy building materials: an overview. In: *Proceedings of the Environment 2010: Situation and Perspectives for the European Union*. Porto: Portugal. 6-10 May 2003; p. 16-21.
- [3] UNEP. *Handbook for the International Treaties for the Protection of the Ozone Layer*. United Nations Environment Programme. Nairobi: Kenya 2003.
- [4] Viktor D. Ventilation concepts for sustainable buildings. In: *Proceedings of the World Renewable Energy Congress VII*, p. 551, Cologne: Germany. 29 June – 5 July 2002.
- [5] Lam JC. Shading effects due to nearby buildings and energy implications. *Energy Conservation and Management* 2000; 47(7): 647-59.
[http://dx.doi.org/10.1016/S0196-8904\(99\)00138-7](http://dx.doi.org/10.1016/S0196-8904(99)00138-7)
- [6] Raja J, Nichol F and McCartney K. Natural ventilated buildings use of controls for changing indoor climate. In: *Proceedings of the 5th World Renewable Energy Congress*. Florence: Italy. 20-25 September 1998; V. p. 391-394.
[http://dx.doi.org/10.1016/s0960-1481\(98\)00193-1](http://dx.doi.org/10.1016/s0960-1481(98)00193-1)
- [7] Limb MJ. Air intake positioning to avoid contamination of ventilation. *AIVC* 1995.
- [8] Miller G. *Resource conservation and management*. Wadsworth Publishers. California: USA 1990; p.51-62.
- [9] Erlich P. *Forward Facing up to Climate Change*, in *Global Climate Change and Life on Earth*. RC Wyman (ed), Chapman and Hall, London 1991.
- [10] ASHRAE. Energy efficient design of new building except new low-rise residential buildings. BSRIASHRAE proposed standards 90-2P-1993, alternative GA. American Society of Heating, Refrigerating and Air Conditioning Engineers Inc, USA 1993.
- [11] Molla M. Air pollutants and its probable transmutation in the ionosphere. *Renewable Energy* 1997; 10(2/3): 327-329.
[http://dx.doi.org/10.1016/0960-1481\(96\)00087-0](http://dx.doi.org/10.1016/0960-1481(96)00087-0)
- [12] Bahadori M. A passive cooling/heating system for hot arid regions. In: *Proceedings of the American Solar Energy Society Conference*. Cambridge. Massachusetts 1988; 364-367.
- [13] Dieng A and Wang R. Literature review on solar absorption technologies for ice making and air conditioning purposes and recent development in solar technology. *Renewable and Sustainable Energy Review* 2001; 5(4): 313-42.
[http://dx.doi.org/10.1016/S1364-0321\(01\)00004-1](http://dx.doi.org/10.1016/S1364-0321(01)00004-1)
- [14] Lobo C. Defining a sustainable building. In: *Proceedings of the 23rd National Passive Conference*. American Solar Energy Society (ASES'98). Albuquerque: USA. 1998.
- [15] Crisp V, Cooper I and McKennan G. Daylighting as a passive solar energy option: an assessment of its potential in non-domestic buildings. Report BR129-BRE. Garston. UK 1988.
- [16] Horning M and Skeffington R. *Critical loads: concept and applications*. Institute of Terrestrial Ecology. HMSO Publishers Ltd. London: UK 1993; p. 23-27.
- [17] Humphrey's M. *Outdoor temperatures and comfort indoor*. *Building Research and Practice* 1978; 6(2).
- [18] Givoni, B. (1998). *Climate consideration in building and urban design*. New York: Van Nostrand Reinhold. 1998.

- [19] Koenigsberger O, Ingersoll T, Mayhew A and Szokolay S. Manual of tropical housing and building. Part 1: Climate design. Longman p.119-130. London: UK 1973.
- [20] Boulet T. Controlling air movement: a manual for architects and builders. McGraw-Hill, p.85-138, New York: USA 1987.
- [21] Szokolay S. Design and research issues: passive control in the tropic. Proceedings First World Renewable Energy Congress, p.2337-2344, Reading: UK 1990.
- [22] Borda-Daiz N, Mosconi P and Vazquez J. Passive cooling strategies for a building prototype design in a warm-humid tropical climate. *Solar and Wind Technology* 1989; 6: 389-400.
[http://dx.doi.org/10.1016/0741-983X\(89\)90058-1](http://dx.doi.org/10.1016/0741-983X(89)90058-1)
- [23] Givoni B. Laboratory study of the effect of window sizes and location on indoor air motion. *Architectural Science Review* 1965; 8: 42-46.
<http://dx.doi.org/10.1080/00038628.1965.9696139>
- [24] Fanger P. Thermal comfort: analysis and applications in environmental engineering. Danish Technical Press 1970.
- [25] Fordham M. Natural ventilation. *Renewable Energy* 2000; 19: 17-37.
[http://dx.doi.org/10.1016/S0960-1481\(99\)00012-9](http://dx.doi.org/10.1016/S0960-1481(99)00012-9)
- [26] Awbi H. Ventilation of buildings. Spon Publisher. London: UK 1991; p. 9-13.
<http://dx.doi.org/10.4324/9780203476307>
- [27] Givoni B. Man climate and architecture. Applied Science Publisher Ltd. London: UK 1976; p.289-306.
- [28] BS 5454. Storage and exhibition archive documents. British Standard Institute. London 1989.
- [29] Lazzarin RD, Ascanio A and Gaspaella A. Utilisation of a green roof in reducing the cooling load of a new industrial building. In: Proceedings of the 1st International Conference on Sustainable Energy Technologies (SET), Porto: Portugal. 2002; p. 32-37.
- [30] David E. Sustainable energy: choices, problems and opportunities. The Royal Society of Chemistry 2003; 19: 19-47.
- [31] Zuatori A. An overview on the national strategy for improving the efficiency of energy use. *Jordanian Energy Abstracts* 2005; 9(1): 31-32.
- [32] Anne G and Michael S. Building and land management. 5th edition. Oxford: UK. 2005.
- [33] Randal G and Goyal R. Greenhouse technology. New Delhi: Narosa Publishing House 1998.
- [34] Yadav I and Chauadhari M. Progressive floriculture. Bangalore: The house of Sarpan 1997; p.1-5.
- [35] EIBI (Energy in Building and Industry). Constructive thoughts on efficiency, building regulations, inside committee limited. Inside Energy: magazine for energy professional. UK: KOPASS 1999; p.13-14.
- [36] Cheng R. Advanced biofuel technologies: status and barriers. World Bank Report WPS5411, 2010.
- [37] Cihan G, Dursun B, Bora A and Erkan S. Importance of biomass energy as alternative to other sources in Turkey. *Energy Policy* 2009; 37(2): 424-431.
<http://dx.doi.org/10.1016/j.enpol.2008.09.057>
- [38] Kothari DP, Singal KC and Rakesh Ranjan. Renewable energy sources and emerging technologies, 2nd Edition, Private Ltd, New Delhi 2011.
- [39] Syifaul F, Mohammad P, Thobib N and Risfanda A. Application of photovoltaic cells as a power supply for smart greenhouse project, *KnE Energy* 2014; 2: 165-171.
- [40] Omer AM. Renewable energy technologies and sustainable development. *International Journal of Current Research in Biological Sciences* 2015; 1(6): 6-24.
<http://dx.doi.org/10.4018/978-1-4666-8433-1.ch008>

Received on 26-01-2016

Accepted on 24-06-2016

Published on 31-07-2016

DOI: <http://dx.doi.org/10.15377/2410-3624.2016.03.01.2>

© 2016 Abdeen Mustafa Omer; Avanti Publishers.

This is an open access article licensed under the terms of the Creative Commons Attribution Non-Commercial License (<http://creativecommons.org/licenses/by-nc/3.0/>) which permits unrestricted, non-commercial use, distribution and reproduction in any medium, provided the work is properly cited.